



SPRAT

THE JOURNAL OF THE G QRP CLUB

DEVOTED TO LOW POWER COMMUNICATION

ISSUE Nr. 173

© G-QRP-CLUB

WINTER 2017/18



A ceramic DC receiver in an iPhone box

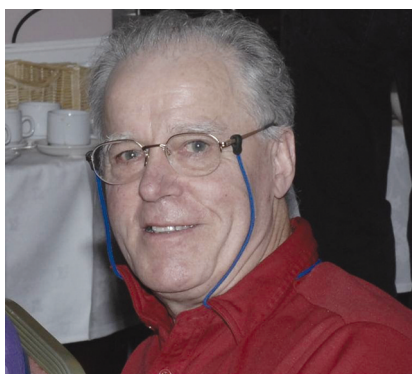

GM3OXX SK

We are pleased to announce the new Sprat-on-DVD. See page 12

A Discrete Ceramic DC receiver ~ Tribal Knowledge

The County Comm GP5/Tecson PL 365 Review

Simple AM Top Band TX ~ The NORCAL Sierra Revisited

Modifying 5V Switching PSUs ~ A 4 Meter Super-regenerative Receiver

Modifying the MFJ-901 Resistive Bridge ~ TDA 2822 Amplifier Chip

A New Regenerative Receiver ~ Optical Coupling

Antennas Valves & Vintage ~ Valve QRP day

Members' News

YOUR SUBSCRIPTION IS NOW DUE – SEE CENTRE PAGES

JOURNAL OF THE G QRP CLUB

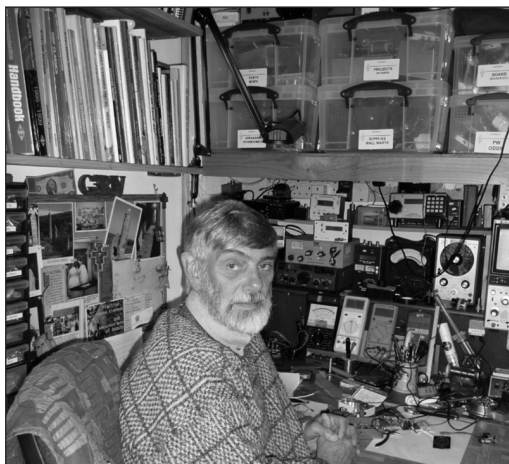

© G QRP

**9 Highlands
Smithy Bridge
Littleborough, Lancs.
OL15 0DS. U.K.**

**Tel: 01706 - 377688
(overseas tel: +44 1706 377688)
Email : g3rjv@gqrp.co.uk
Homepage : www.gqrp.com**

Rev. George Dobbs G3RJV

I am really sorry to have to tell you that George Burt, GM3OXX, a very early member of the club, died in September. Unfortunately, most of us were away when the funeral was held in Edinburgh, but our QSL Manager, Dave Coutts, GM3VTH represented the club. I have recently had 2 or 3 members say they regret that the QRP Convention at Rishworth "is no more". We couldn't have continued there, but the Telford Hamfest was a very worthy successor to the Rishworth event. During the day we had three excellent talks in the stylish old company board room. The hall was well filled with traders selling a variety of components and surplus equipment in the tradition of the old "radio rallies". After the appeal in the last Sprat for the re-submission of missed articles, we have been really pleased to get so much that seems to have got lost somewhere, and a lot of this Sprat consists of these "lost" pieces. Please continue to send anything for Sprat to both Graham and I, then we have a backup file. Contact either of us for a SPRAT formatted page. Can I add my thanks to Graham G3MFJ and others who helped with this issue, I have had a few health problems. They rescued me several times.

72/3

**This could be your last SPRAT. Check your delivery label
and please read the Membership Secretary's (G4WIF) page**

Printed & Distributed by G QRP Postal Mailing

George Burt GM3OXX - SK

George Dobbs G3RJV

It is with deep regret that I have to inform you of the death of George Burt, GM3OXX, a radio amateur in the real sense of the word. For George the rules were simple: he built all his own equipment and never ran more than one watt of RF power. His transceivers were based upon converters with a tuneable IF for each band. This was radio construction at its finest. I recall one observer calling it "amateur radio jewellery".

George had a concern for the beginners in the hobby and to that end he introduced several well-known beginners' practical projects. Their names show the link with George. He never claimed any acknowledgement for these popular projects The OXO, The Oner and The Foxx.



At a talk in Houston Texas, I helped George to pass around his equipment for closer inspection. This was a mixed blessing because the speaker after George complained about the time it took to get the equipment back before he could begin his talk. I am lost as to his DXCC score. All of his contacts were gained using simple wire antennas. He was a modest and lovely man and an example to us all.

Thank you George!



A Discrete Ceramic DC Receiver in an iPhone Box

Bill Meara N2CQR

Here is a little DC RX intended to encourage receiver construction. The circuit is completely understandable – it features discrete components with no mystery chips. Parts are easily obtained – there is no “unobtainium”.

The oscillator is built around a 7.3728 MHz ceramic resonator – with a 6.6uH coil and a polyvaricon I can tune the entire 40 meter band (I used a reduction drive). The mixer is a singly balanced design inspired by F5LVG’s RX-20 (SPRAT 100); it balances out the incoming RF and this does a great job in preventing AM breakthrough. The AF

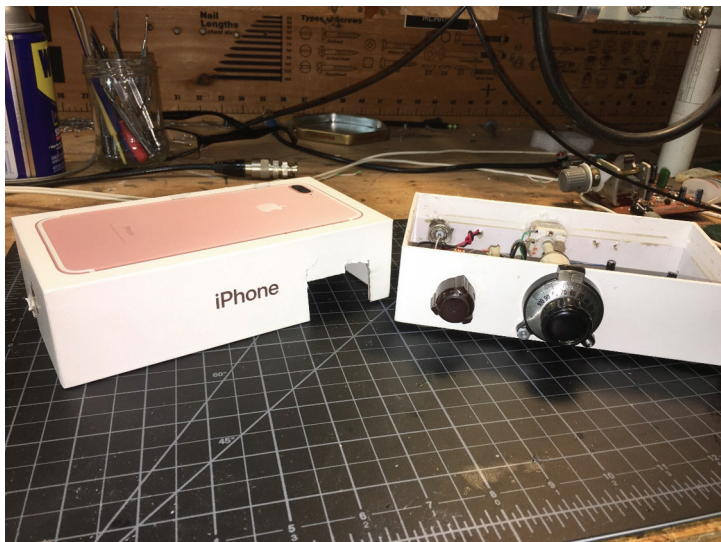

amplifier is designed to work into ear buds. You could also run the RX into a powered computer speaker for easy listening.

With my teenage nephew in mind, I built my prototype into the box from an Apple iPhone 6 Plus. Young John Henry will be testing the new RX for me. Thanks to VU2ESE, PY2OHH, W7ZOI, F5LVG, PV2AL, N7SUR, N6QW and John in Freiburg all of whom provided support and/or inspiration.

Note: A full resolution version of the circuit can be downloaded from www.gqrp.com/iphonerx.htm

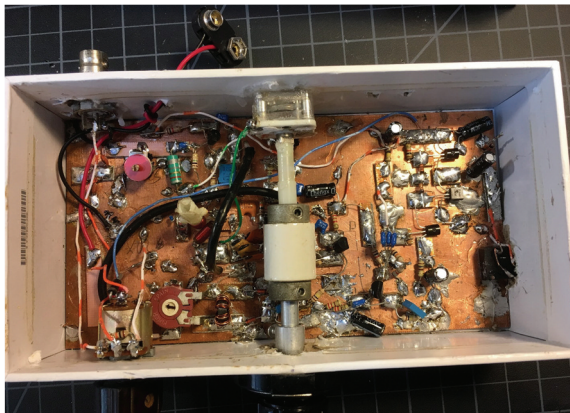

Tribal knowledge from Ralph and Hans

Nick Tile, G8INE, juggie@cix.co.uk

This article has its roots in an email exchange with Tony G4WIF over a low pass filter or similar. Tony casually observed, quite correctly, that I didn't actually know that my frequency counter was accurate. I had always assumed that it was based on the organisation that sold it me assuring me that they had checked it first, but it was second hand and far from in its prime.

Tony's observation stayed with me until I happened to come across an article in QEX July/August 2015, "An Arduino Controlled GPS Corrected VFO" which used a GPS receiver to improve the frequency accuracy of an Si 5351 clock generator breakout board. An added benefit for me was that I had all the major components in my junk box except the GPS device which was available at a very good price from the usual source of such things and which was duly ordered. The device works by using the very accurate 1 pulse per second output from the GPS receiver which is routed to the Arduino's interrupt 0 input port (pin D2) to act as a counter gate. The Arduino counts the 2.5 MHz input over a 40 second gate time, resulting in a 100 MHz total count. This count is used to recalculate the 25 MHz clock frequency. Total system uncertainty, including calculation resolution limitations and clock drift during counter gate time, is better than 1 part in 10 million.

Anyone building this device should note that the software that is suggested has been superseded for a later version with additions by Jan, PE1CID and that before it will run, a slight change may need to be made to the data rate between the Arduino and the GPS device, by default it's set to 4800 baud but many GPS devices output at 9600 baud. Using that, I was able to check my counter and established that after it had warmed up, it was about 5 Hz low at 10 MHz which acted as the springboard to check the accuracy of a few more of the meters that I use around the shack, in particular, the inductance meters, a Peak LCR meter, and an AADE LC meter. Both meters have been a cause of concern for some time because when I wound a toroid to build a filter or some other frequency based device, I was consistently finding that whilst the instructions matched the data given in the GQRp tables and similar tables elsewhere, I usually had to remove one or two turns to get the meters to show the desired value.

Eventually, I embarked on an exercise to determine how accurate the meters were and why my coils were never "right". After further research and more conversations with Tony, I obtained some +/- 470pF polypropylene capacitors and wound some coils based on T37-6 toroids so that the coil and capacitor combination would resonate close to 7 MHz. The excellent Toroid Inductance Chart, submitted by David Smith G4COE on the G-QRP website advised me that 19 turns on a T37-6 should give me an inductance of 1100nH which when placed in parallel with the 470pf capacitor should resonate at 6.999,626 MHz. The bottom of the circuit was connected to the ground side of the scope and counter and the top of the circuit via 10pF capacitors as per this paper:

"Some thoughts about the practical measurement of inductance for the radio amateur", Ralph Klimek, January 2010 -

<http://users.monash.edu.au/~ralphk/inductance-measuring.html>

Source: Ralph Klimek, January 2010

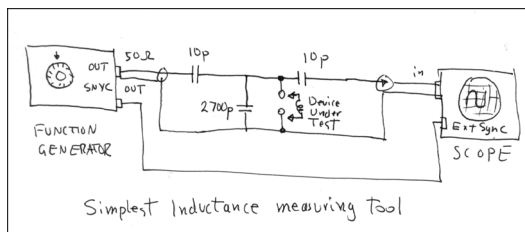

The two source and coupling capacitors make source and scope appear to be very high impedance and are largely swamped by the 470pF capacitor that I used.

A single coil and capacitor were selected to ensure consistency and their values measured:

component	Nominal value	Peak LCR	AADE
capacitor	470pF +/- 2.5%	477.6pF	476.3pF
coil	1100nF	1071nH	1005nH
Calculated Resonance MHz	6.999626	7.037092	7.274393
Observed resonance peak scope display		7.4500 MHz	
Observed peak SNA Jr.		7.4363 MHz	

The experiment was repeated a number of times with broadly similar results suggesting that values were real and that the AADE was a little less accurate than the Peak meter. After much headscratching and a lengthy email exchange with Tony, I concluded that the batch of T37-6 cores I'd bought had a slightly higher Al value. Instead of the published value of 3, it was more like which wouldn't be surprising as I bought a lot of them very cheaply from the usual source. I therefore guessed that they might be cheap as they were a little off spec.

It then occurred to me that I could test my hypothesis by winding the coils on a plastic straw suggested for the early BitX transceivers. Anyone who actually got that to work has my undying admiration as placing the straw under tension by winding a coil on it causes it to deform unpredictably - but it did show that eradicating the ferrite core was a good way to progress. trip to the Co-op and the acquisition of some cheap (subsequently discarded) sweets contained rigid plastic tube provided me with an ideal former 0.67" in diameter.

A few minutes on a web based calculator:

<http://www.daycounter.com/Calculators/Air-Core-Inductor-Calculator.phtml>

.. suggested that 6 turns of 27swg, 0.1" coil length on a 0.67" core would give me 1006 nH

The coil was then tested as the toroidal coil had been:

component	Nominal value	Peak LCR	AADE
capacitor	470pF +/- 2.5%	477.6pF	476.3pF
coil	1006nF	1007nH	1010nH
Calculated Resonance	7.3193 MHz	7.2572 MHz	7.2923 MHz
Observed resonance peak scope display		7.0710 MHz	
Observed peak SNA Jr.		7.0700 MHz	

At that point, I concluded that there was about 200 - 300 nH difference between predicted and measured; 19turns on a T37-6 should be 1100 nH, but I had to take 2t off to get to that because was closer to 1300 - 1400nH which supported my hypothesis that the T37-6 were at fault.

Further research led me to a paper by Hans Summer, "Evaluation of competitor-produced equivalents of Micrometals powdered iron toroidal cores", Hans Summers, January 2014 <http://www.hanssummers.com/images/stories/lpokit/toroid.pdf> . Hans set out to make an evaluation of the cores offered by two manufacturers with a view to ensuring that those that he supplied his kits were accurate. The key passage from his paper states:

"The average inductances differed by only 3%, which is not of any consequence, given the significant variations which occur naturally when windings are squeezed or spaced out.

For example, the calculated inductance for 11 turns on a T37-6 toroid according to the published Micrometals AL values and inductance formula, is 360nH, which is substantially different (19% higher) from the measured 427nH (T37-6).

At first this is alarming, however closer investigation reveals that the formula assumes turns spread evenly across the whole core. The recommendations in the amateur literature are somewhat conflicting. There is consensus that the start and end of the coil windings should not be very close together, to prevent problems with capacitive effects. However, the amount of separation recommended differs considerably.

The G-QRP club website page, on which the LPF filters are based, recommends windings should cover 75% of the core; yet the specified number of turns is based on the formula which assumes even spread over the entire core. Other sources recommend 90% coverage, and some recommend a 30-degree separation which equates to 92% coverage”

I duly followed Hans' comments and opened the coil windings up so it was evenly spaced around the toroid then measured it on the Peak LCR meter where it came up as predicted and was 1100nH. The AADE was a bit lower and closer to 1045nH but a little less stable than the Peak - the instructions do suggest that there's a "heating" effect, so it may well have been stabilising. Soldering the coil into the test rig I was using previously, resonance on the scope occurred at 6.920 MHz- it was too flat to get a sharper peak which may be down to the resistive load of the scope across the circuit, stray capacitance etc. The calculated peak for those values is 6.943711 MHz. The SNA jnr gave a very similar peak at 6.9219MHz (centre of the indicated peak, its display is actually a series of tiny flat bars on the display) so is remarkably close agreement with the scope / signal generator and suggests that the measurement is good too. A subsequent check on the signal generator display against the warmed up counter showed that it was accurate to within a few Hertz at the most. I guess, from all of that, I have to conclude that my original thesis was wrong and that my “cheap” toroids are probably pretty close to spec, but that I've been winding them in the wrong way and should be spacing them around the whole ring.

It was only by following the advice that is contrary to that given in many places in respect of the gap at the end of the windings did I get an accurate coil, but I am reluctant to suggest that the wisdom that I have seen in many places is actually wrong.

There are also clearly implications to the two ends of the coil being close together that I have not as yet investigated. That said the majority of the boards that I've built actually set the spacing at the common convention with a gap between the start and finish of the winding, 75% of the core or a 30-deg. gap (92% of the core).

References:

An Arduino Controlled GPS Corrected VFO, Gene Marcus, W3PM/GM4YRE
http://www.ar1l.org/files/file/QEX_Next_Issue/2015/Jul-Aug_2015/Marcus.pdf

Toroid Inductance Chart

http://www.ggrp.com/toroid_inductance_chart.pdf

“some thoughts about the practical measurement of inductance for the radio amateur”, Ralph Klimek, January 2010
<http://users.monash.edu.au/~ralphk/inductance-measuring.html>

“Evaluation of competitor-produced equivalents of Micrometals powdered iron toroidal cores”, Hans Summers, January 2014
<http://www.hanssummers.com/images/stories/lpokit/toroid.pdf>

SNA jnr. DuWayne Schmidlkofe kv4qb - <http://kv4qb.blogspot.co.uk/2015/03/sna-jr.html>

County Comm GP5 SSB / Tecsun PL365 Handheld HF Receiver Review

Andy – G0FTD - andyfoad@rocketmail.com

The County Comm GP5 SSB, also known as Tecsun PL365 is a rather unusual handheld multi-purpose DSP HF receiver, covering 150KHz – 30MHz with 1KHz a steps, and 10Hz steps via the BFO, plus FM broadcast. The GP5 is available from sources in the USA. The Tecsun is available from China and Hong Kong, and such sources are usually easier to import into the UK, without the usual customs issues. There is also a non SSB version around, so ensure that you choose the correct one. Price is around £70. Switchable USB/LSB is provided plus AM. The receiver requires 3 x AA cells or USB cable input. Unusually the s-meter reads as dbuv (db above a microvolt across 600 ohms) and SINAD. The SINAD meter appears to have a full scale deflection on AM of 25db. On broadcast FM I have seen it reach 44db. The SINAD meter requires spot on tuning accuracy, otherwise it reads zero. The SINAD meter does not work in SSB mode. Both the signal meter and SINAD meter is available on all frequencies, but requires a steady carrier whence there is no signal meter in SSB mode. This is hardly a deal breaker. The photo below shows the signal meter and SINAD meter in action (38 dbuv and 16 db signal to noise ratio whilst tuned to a local broadcast signal for convenience).

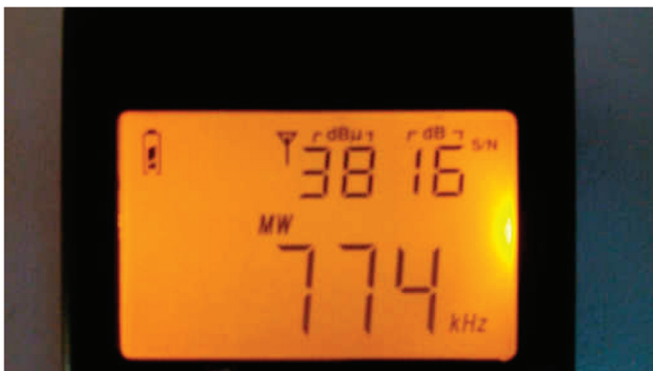

This receiver is an extremely small and lightweight device, and perfect for keeping an ear on the HF bands before firing up the main rig, or to be used alongside a companion QRP transmitter for extremely compact /P operations, which is why I feel it deserves a mention in SPRAT

An external antenna socket is provided (believed to be 600 ohms) and takes all signals except broadcast FM. The receiver also comes with a short clip on wire antenna for HF use which helps with sensitivity, not that it really needs it. That 18 whip is usually enough. There is an inbuilt ferrite rod which works well on medium wave, but poor on LW. An external ferrite rod is provided, which improves the sensitivity, or you can provide your own loop or wire.

With a half decent ferrite rod, I could hear a band full to bursting with NDB's around 350KHz, and a long wave band full of broadcast signals.

I even discovered that Denmark has a LW TX that only gets switched on four times a day for a quick news and shipping forecast on 243KHz 1. It's a good receiver for the 475KHz amateur band too. I even used the receiver's unique signal meter to tune my QRPp 475KHz transmitter aerial coupling unit. One tip, if you decide to provide your own external ferrite rod or loop antenna the lower frequencies, then I suggest you feed it via a few feet of screened cable and keep the external antenna away from the actual receiver. This is because the receiver is not well screened, and some processor noises may be heard if the antenna is too close. There are no issues on 160-10m, no noises are received at all.



With this receiver it is essential to set up the memories first, and then tune from them via the VFO mode otherwise tuning would take forever via the sidewheel provided.

Now let's get one thing straight, these receivers work! On 160m and an 18 inch whip, I can listen to any signal I want with ease. Don't assume that these are like the old style VHF/UHF scanners with deaf HF coverage, because they are not. I could listen to all participants on the usual Sunday afternoon 160m Amplitude modulation AMPSNET in Kent and Essex, just like I had a £1000 rig and a 150ft long wire, and all on that on 18 inch telescopic. QSO's on 3560KHz during the day were heard, a rare 20MHz appearance of WWV one afternoon and on 28MHz I listened to weak beacons easily enough too. I can honestly say that at no time did I ever feel I was missing out on signals with such a tiny set up. In fact, I'm thinking of getting another one! If there was one feature that this receiver excels at, it is sensitivity.

So is there anything bad about the receiver? Well the rig is made of plastic, not a die cast shell. So it might not survive any drops if you are careless. But it does make a VERY light receiver. Also, the lack of screening affects the BFO a little when handling the receiver.

I detected $\pm 50\text{Hz}$ wobble at 28MHz as I brought my hand near to the receiver, but almost un-noticeable at 7MHz . It's a little disconcerting at first but other than that everything is perfectly stable and useable. Also the belt clip is pretty flimsy, and I doubt it will withstand much use. It does unclip and can be removed.

Broadcast performance is excellent. The use of the ETM (Electronic Tuning Mode) scans all broadcast bands and allocates received signals into the separate ETM memories that do not affect the user memories. I actually found this very good, and it has re-awakened my interest in HF broadcast listening. Pressing and holding the down arrow button sorts these memories in to frequency order. FM broadcast works well, with excellent sensitivity too. Other useful features include a clock, and a thermometer in Fahrenheit or Centigrade.



In recent times, I have started to collect these modern receiver marvels since they are very cheap, and offer what I call the “third way” of operating QRP. That is having a small receiver ready built, but using a homebrew companion transmitter to keep the home brew spirit alive. I can recommend searching Youtube for the M0DAD reviews of this receiver. They concentrate well on the HF SSB performance. The others videos that I found were way too long and boring, and told me nothing. These are great little receivers, and I often find an excuse just to go for a walk and a listening session. And if I feel propagation is good, then I make the effort to bring out the FT817 not long after.

Recommended outlets are -

(A) <http://www.anon-co.com/> (very fast)

(B) Ebay retailers

(¹) 05:45, 08:45, 11:45 and 17:45 Danish local time

Simple AM Top Band TX

Peter Howard G4UMB

I was using my CW modular transmitter in Sprat No 163 and had the idea to combine it with the modulator from The Small Talk transmitter in Sprat No 133 to make a simple AM Transmitter for chatting locally. The circuit below evolved by removing the keying transistor in the CW rig and replacing it with a transistor in series with the PA driven by an audio source from the 2 Watt amplifier in the Small Talk Transmitter. With a 24v supply to the CW part and 12v to the Audio amp. It runs at about 6 Watts out but has downwards modulation. The TIP41 & BD140 both need good heat sinks. The LT100 transformer is a miniature output type sold by Maplins Pt No LB14Q. But I tried out different transformers from the junk box and they all worked. Unfortunately the level of QRN on Top Band these days make QRP AM contacts difficult above a 5 mile radius. But it should work OK across town. The circuit is designed for a condenser (electret) microphone. The output filter was designed for a 1.836MHz crystal which the club sells. All made on stripboard.

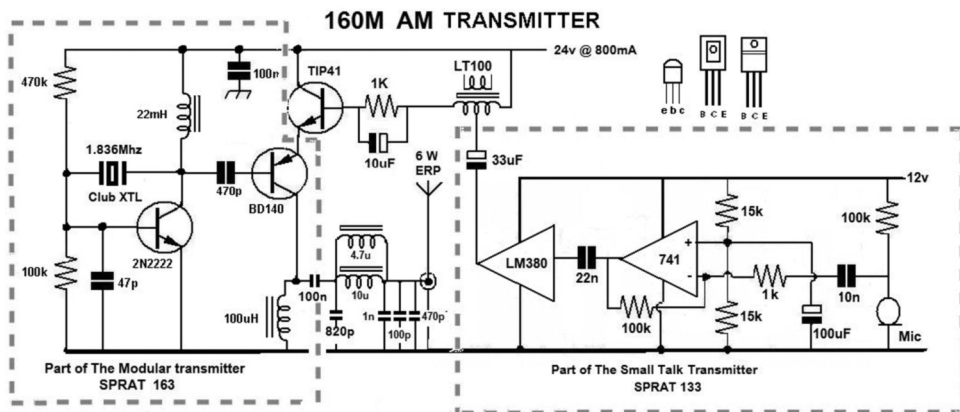

The New Sprat-on-DVD

Graham Firth G3MFJ

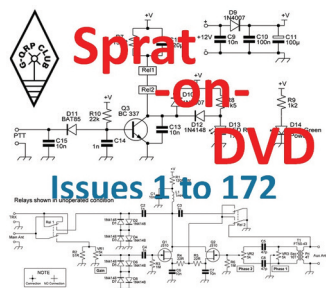

As you may have spotted on the front cover, we have a new Sprat-on-DVD which includes Sprats 1 through 172 - the last (autumn) issue. It is a team effort, Tony does the HTML contents of the DVD, I do the artwork & ordering. Mike, our printer, supplies the PDFs of each issue as he reads them for printing. Also included is the up-to-date index as provided by our index guy - Bill, K7WXW. We have kept the price the same - £5 to members, and £12 to non-members. Postage is the almost the same as before - UK - £1, EU - £3, and DX - £4. (Slightly cheaper, now we have our own franking machine)

The full set - 1975 to 2017 © G-ORP Club 2017

The Norcal Sierra revisited

Stefan Bauer DM5TU 8769 dm5tu@verschalter.de
Nigel Flatman G0EBQ 3375 nigel.flatman@yahoo.com

In the year 1994, Wayne Burdick N6KR designed the Norcal SIERRA. Thanks to the efforts of Doug Hendricks KI6DS and the late Jim Cates WA6GER, the design was first promoted as a NORCAL club project then later sold commercially. Unfortunately the SIERRA is no longer available in kit form. The rig is a classic QRP multi band CW transceiver that achieves band switching by the use of a changeover plug in band module. Construction of a multiband rig is tricky and this is a neat solution.

Originally the Norcal SIERRA covered the CW portions of the 80M, 40M, 30M, 20M and 15M bands, then the later commercial versions covered all bands from 160M to 10M; Stef DM5TU's Autumn Sprat article added a 60m option. The receiver is a single conversion superhet with audio derived AGC, and RIT. The transmitter has full break-in keying,

while optional circuitry allows monitoring of relative power and signal strength. The CW output power is about 2-3 watts. The transceiver has a number of analog ICs, which simplifies the construction process. If the builder wants a moderately complex homebrew transceiver project, with room for further experimentation, then this classic QRP rig is the way to go. Although over 20 years old, it

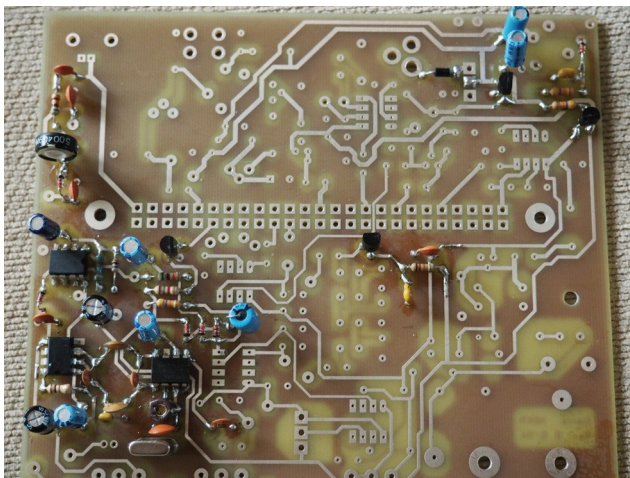

The part finished Sierra board

remains an excellent multiband QRP rig.

Hams are creative and often search for solutions to get on the air with the rigs they demand. Various hardware solutions had been built and reconstructed in different types; what they have in common is the basic design based on the one by Wayne Burdick N6KR. For example Nigel G0EBQ built his main board using perfboard - far from ideal. For the plug in band modules he had to use commercially produced PCBs, which were not great quality.

Stef had his commercial kit version of the SIERRA in his shack boxes unbuilt for almost 19 years. He started building in 2016. He as well did not have all the needed band modules. So his search began.

This is how Stef and Nigel met, both stuck over the poor quality of the band module PCBs from across the pond.

With permission of Wayne Burdick N6KR, GQR Club member Stef, DM5TU, was able to bring out high quality PCBs for band modules. These band module PCBs, as described in the last issue of Sprat, are good for all SIERRA versions - the original 1996 ARRL Handbook version as well as for the later Wilderness version sold commercially. These are plated through where necessary and are of very high quality; thanks are due to Dirk Ruffing DH4YM, without whose hard work in the development and production this project would not have been possible.

The circuit and constructional info for the Norcal SIERRA is still freely available for download at (1), with a comprehensive description, photos and full constructional and alignment information.

An essential source of further information for the more ambitious SIERRA builder is (2), the Yahoo Sierra Wilderness Radio Group, which we would strongly urge all prospective constructors to join and which gives details of the many modifications possible, as well as now having the original and very comprehensive Norcal constructional manual available for download. If desired of course the VFO and premix circuitry could be replaced by a DDS VFO.

If you are interested in the modifications relating to the time when the SIERRA was developed in the late 1990s, the complete issues of QRPP - the Journal of the Northern California QRP Club - are available to download from Norcal at (3). Great stuff!

So what's new?

We are pleased to announce that Stef DM5TU, together with Dirk DH4YM have produced both main and band module boards on a non-profit basis, and that these are stocked by GQR Club Sales at a price of £12.00 for the main board and £8.00 for the band modules. Better still; GQR Club Sales also stock most of the more expensive or hard to get components including the card edge connector to take the band modules.

Nigel has built a prototype using Stef and Dirk's boards, and used a club BF256b in the VFO (but use J309 or similar for the premix and buffer to ensure sufficient drive) and half a club BB204 for the IRT, ordinary 2N3904/6s and 1N4148s for the low level transistors and diodes. 64 turns of magnet wire - about 35swg on a club T50/7 with a 60pF Murata trimmer and changing C53 to 150p resonated the VFO perfectly. The prototype is working nicely and has given many pleasant QSOs already, and puts out 1.5W with plenty in hand. Your full shopping list from Club Sales is, for each main board, 1 main board PCB, one edge connector, SA602x4, MC1350, LM386, J309x2, BF256B, BB204, 1 pack each of 2N3904, 2N3906 and 1N4148, 4.915MHz crystals x 7, 60p Murata trimmers x 3, 1 pack each of T50-7, FT37-43 and FT37-61, 15uH and 1mH HF chokes and the appropriate copper wire. The non-normal-stocked items are listed below (7)

For each band module you will need a band module PCB plus 7 Murata trimmers, and 8 of either FT37-61, T37-2 or T37-6 depending on the required band, the 11.5, 13.25 (13.225 for the UK), 15, 18, 22, 26 and 29MHz crystals needed for all bands from 80m to 15m (including 60m), and the appropriate copper wire for the toroids!

JAB, Bowood, or eBay should provide everything else and with careful shopping and a reasonable junk box it should be possible to build a 4 band rig of excellent performance for under £100.

When constructing the rig, mount the edge connector first before you do anything else. Ensure that all connections around it are good as it needs to be joined to tracks both above and below the board. Also take care of continuity where in several places the track needs to be joined through the hole above and below. Of course check orientation when using alternatives to the original devices; note that the board does allow mounting of alternative transistor types for the final, the various modification files on the Yahoo site offer several options.

Note that this PCB (as taken from the ARRL original) contains only the power and not S meter circuitry as shown in the ARRL article; there is a separate output on the board for an S meter if required. Also the specific PCB mounting components from the original project back in 1994 will not now be available and the constructor will need to use what they have and hand wire these to the enclosure panel. Constructors may also prefer to use a readymade commercial enclosure, which will not then be an exact fit, and their own preferred sockets such as UHF.

A good and relatively inexpensive source for custom “handmade” crystals is via (4) the KRYSTALY, Hradec Kralove, a.s. in Ceska Republika. Here custom crystals were about 6 Euros per piece plus tax and shipping.

Details of the Murata trimmers are at (5), these may be mounted flush to the board or at right angles as in the original and commercial versions of the SIERRA (see photo in Stefs article in the Autumn Sprat).

Tip; do not buy the remakes of the trimmers from China. You get 50 pieces for about 9 Euros - they are not worth the money! Also beware of fake 2N3553s and 2N2222As on EBay.

The main board and band module PCBs, with gold plated fingers for the band modules, are available at (6) Dirk DH4YM as well as GQR Club Sales.

We hope that this short piece will encourage members to rediscover and enjoy this excellent design.

References (1) ARRL.ORG/FILES search under Norcal Sierra

<http://www.arrl.org/files/file/Technology/tis/info/pdf/96hb1789.pdf>

(2) https://groups.yahoo.com/neo/groups/sierra_wilderness_radio/info

(3) <http://www.ncqrpp.org>

(4) www.krystal.cz Email krystal@krystal.cz Krystal Hradec Kralove,a.s.Ceska Republika

(5) MuRata TZ03P600FR169 trimmer cap 6mm 9.8-60pf 100v

(6) Dirk Ruffing, DH4YM www.DH4YM.de Email dh4ym@t-online.de

(7) G-QRP Club sales stocks the following extra parts (+postage as for parts):

Main PCB boards £12 each (the band modules are £8)

Edge connector £4 each

Murata trimmers 60p each

BF256B 50p each

J309 50p each

13.225MHz crystals £1.50 each

29.0MHz crystals 50p each

4.915MHz crystals 50p each

Modifying 5 volt switching power supplies

Colin McEwen G3VKQ

Small 5 volt switching power supplies operating from 110-240 v input and capable of up to 2 amps are readily available. Sometimes for free from discarded mobile phones. I wanted to find out if I could modify units to supply 6.3v at 1 amp for the heater supply in a valve project.

Design Aspects

The designers appear to have had selectable / variable output voltages in mind. This is no surprise - OEMs would love a reliable design covering a variety of markets and applications.

The design concepts appear to be

[1] Design for full output at lowest possible line input - typically 100v AC for a nominal 115v application;

[2] Use feedback to define the output voltage [good design practice].

[3] Choose components capable of operation at 264 v (max of 220/240 nominal line) and ensure that feedback has enough control range to throttle back the supply to maintain output voltage control.

Figure 1 shows a block diagram of a typical switching phone charger or small IT psu.

The output voltage is controlled by comparing the output with a reference and feeding back a control signal to the switching element, via an opto-isolator. If the output is too high then the switcher is turned off and when the output has decayed the switcher is turned on again. There will be ripple on the output voltage but this is unimportant in the phone charger application. It is also unimportant when supplying valve heaters.

From a UK/European perspective, operating on 220/240v line voltages, this design approach means that a nominal 5volt DC psu is capable of more output voltage simply by altering feedback component values. There will be enough throughput to support higher output voltage but do check the voltage rating of any output reservoir/smoothing capacitors. One unit I worked on used 6.3v rating output components.

Units operating on 115v line input may not have the same scope for increasing output voltage. If you do not require the full output current from your unit then it is still worth a try !

Please take care – there are lots of nasty volts in these things and although the output may be low volts, the input side connections will be very unhealthy!

Output Voltage Control

I have encountered two approaches to output voltage control. Both are based on a “programmable Zener diode” voltage reference such as the TL431 or KA431.

Figure 2 (a) shows the essential components of the “programmable Zener”. If the Reference terminal is connected to the cathode, as shown in Figure 2(b) then the device acts as a 2.5volt Zener (with much sharper knee than a conventional Zener). If the Reference terminal is fed from a resistive divider, as shown in Figure 2 (c), then the device acts as a Zener of value $2.5*(R1 + R2)/R2$ volts.

Voltage Control Method 1.

A simple low cost low accuracy method is shown in Figure 3. I found this in a 5volt USB hub supply.

The output voltage is applied to the programmable Zener in series with the input (opto-emitter) of the optoisolator. The Zener is programmed to voltage V_z and the opto-emitter forward voltage is V_f (approx 1v typically). If the output voltage is more than $V_z + V_f$ then the opto conducts and the switcher is turned off. Conversely when the output voltage has decreased then the opto ceases to conduct and the switcher is turned back on.

Using the arithmetic given above, and assuming $V_f = 1$ v, then the output voltage V_o is given by

$V_o = 1 + 2.5*(R1+R2)/R2$ volts approximately.

Reducing R_2 , by replacement or by adding R_3 in parallel as shown in Figure 3, will increase the output voltage.

This is a low accuracy method - the output depends on the exact value of V_f which is not well controlled and varies with temperature. However the method is very cheap and works well in the intended applications.

Voltage Control Method 2.

Better accuracy can be obtained if your unit uses the approach of Figure 4. I found this in a Motorola phone charger [Motorola 163-1149].

The programmable Zener is set up for a voltage less than the lowest intended output voltage. Typically the programmable Zener is set to the 2.5v minimum achieved with the TL431 by strapping Reference to Cathode as shown in Figure 2(a).

The output voltage is sampled using a resistive divider and compared with the reference, as shown in Figure 4. Suitable choice of R1 and R2 defines the output voltage V_o , where

$$V_o = 2.5 \cdot (R1 + R2).$$

Once again, reducing R2, by replacement or by adding R3 in parallel as shown in Figure 4, will increase the output voltage.

Final Notes

Note 1. The line input side of this type of supply uses direct-off-mains connection. The low voltage side is isolated via the transformer insulation and the opto-isolator. Make sure that you maintain this isolation.

Note 2: Switching converters can generate EMI/hash, typically audible on a 198kHz Longwave receiver [audible but not overpowering my Droitwich locked frequency standard]. I have not experienced this as a significant issue on the HF bands.

Figure 1. Switching Power Supply

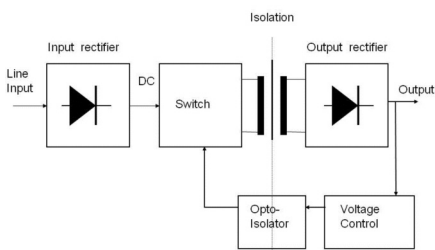

Figure 2. Programmable Zener

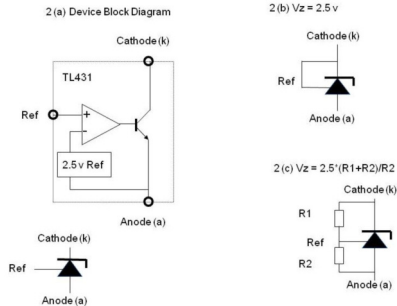

Figure 3. Method 1 Voltage Control

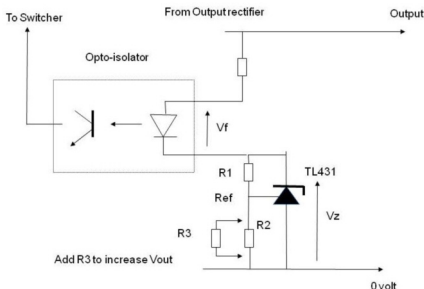
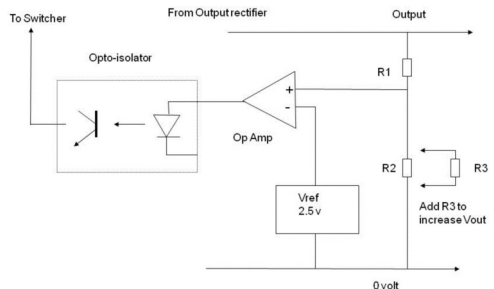

Figure 4. Method 2 Voltage Control



A 4 Meter Super-regenerative Receiver

Ken Maxted, GM4JMU

18 Castleton Avenue, Newton Mearns, Glasgow G77 5NF,
kenneth.maxted@tesco.net

I built a modified version of a fairly standard FET super-regenerative receiver that enables copy of narrow-band FM on 4 meters and makes a delightful radio for monitoring signals near and far. The radio I describe harks back to 1960s designs and for me has provided the joy of a simple but very effective piece of kit that is a pleasure to use.

The original circuit ideas for this receiver were published in F G Rayer, 50 (FET) Field Effect Transistor Projects, Babani Press 1977 and a version by Charles Kitchin appeared in QST 1997. In the late 1960's I built a two transistor super-regen for 2 meters (AM) that used germanium transistors, described in Radio Constructor (1964): it gave me immense fun and from London I copied F8OW in Paris and stations in Sutton Coldfield in the UK, which on 2m counts as DX in any book.

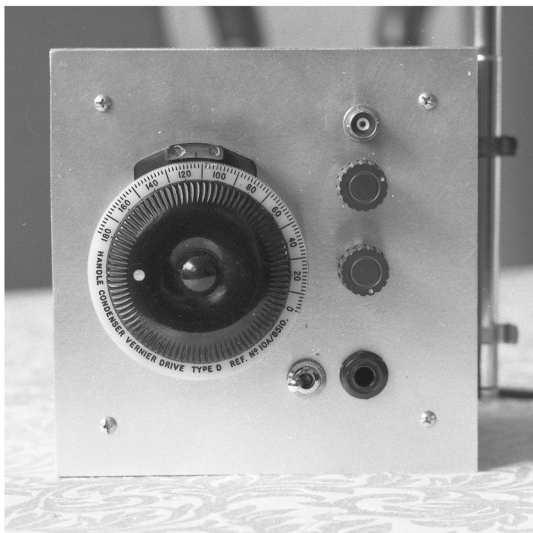

I had tried to replicate that success for FM on 2 and 4 meters with little joy and Charles Kitchin's version with special quench circuitry modifications to enable FM copy did not work for me. The theory was that a saw-tooth quench waveform (that takes the detector in and out of oscillation at an ultrasonic frequency) produces wide sidebands that prevent effective slope-detection of the narrow band FM signals used today. His modification was to introduce a small variable series resistance in the capacitor that determines the quench time-base and this would slow the rise-time of the quench sawtooth. To some extent it does but I discovered that the same effect could be obtained by fine setting of the feedback control pot and all the series resistor was doing was providing a fine-trim control. It then occurred to me that an inductor would, if resonant with the quench capacitor at the quench frequency (approximately 40 kHz) serve to slow the risetime, and in practice it worked very well. For my purpose a series inductor of 1mH in series with a (slightly larger) quench capacitor of 10,000pF was optimal (I used a polystyrene capacitor but mylar and polyester ones should be fine and you will probably get away with a .01uF ceramic although in an AF resonant circuit these are not optimal). I did try a parallel resonant arrangement (see inset). It produced a good sine wave quench signal but it was difficult to eliminate this high amplitude signal from received audio and the regeneration was no smoother than with the series arrangement I finally adopted.

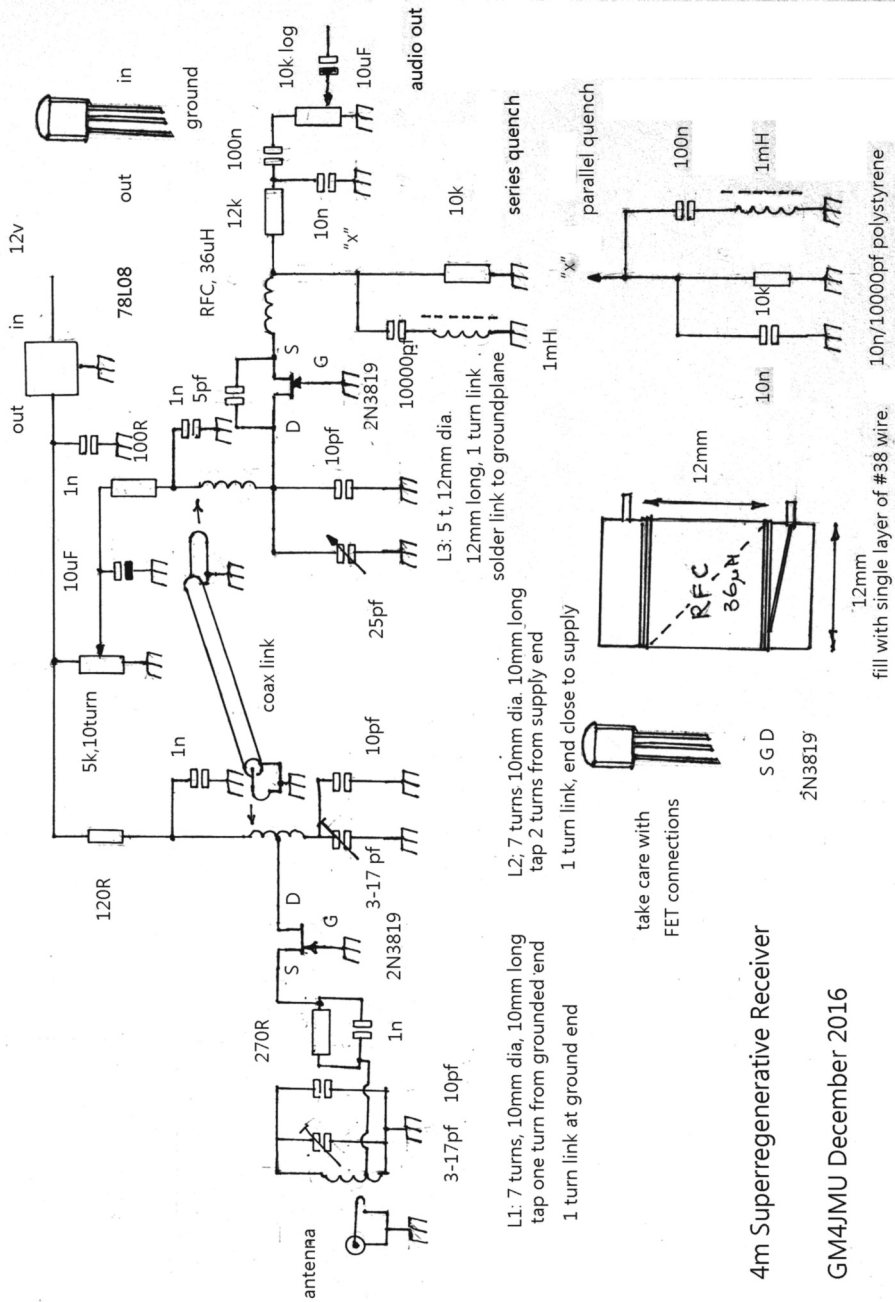

4m Superregenerative Receiver

GM4JMU December 2016

I tried a J310 in the detector but found the onset of regeneration rather fierce and lacking control, other FETs you could try are 2N5459 and TIS88.

The tuned RF stage, again from F G Rayer's book, is a marked improvement over an aperiodic stage: I have tried un-tuned stages but they are tricky to couple to the detector and cause all sorts of regeneration problems. The tuned stage is easy to set up, the grounded gate design is very stable (keep the inductors separated and at right-angle to each other) and it can be coupled to the detector with a short length of coax (I actually used audio coax), enabling the RF and detector to be built on separate boards. The RF stage considerably enhances the stability of the receiver and prevents radiation from the detector. (My old 2m AM receiver of 1966 was audible over several hundred yards!) Please note that the 10pF padding capacitors are absent from the photographs: the tuned circuits are nominally 300nH in parallel with 17 pF.

For the audio amplifier I used an LM386 design (in actual fact one of the G-QRP surface mount kits).

Similarly, any AF amplifier from a direct conversion receiver would give more than adequate gain. The audio is filtered after the detector to cut the supersonic saw-tooth component.

Operation.

Using the receiver is a two-hand task: tuning and regeneration, and there is likely to be

some hand-capacitance effect. However the regeneration control is smooth and predictable

and I can usually preset it and just turn on to monitor the 4m news-nets on Sundays. The regeneration can be increased, first to heterodyne with carriers and then a hiss starts and maximum sensitivity occurs as the detector just goes into full superregen mode. The hiss will get louder as the regeneration amplitude increases but sensitivity will fall off.

Tips on building.

To get the best from the circuit use a ten-turn pot for the regeneration, any value from 1k to 22k will be fine as it is simply a potential divider. When building the detector stage I

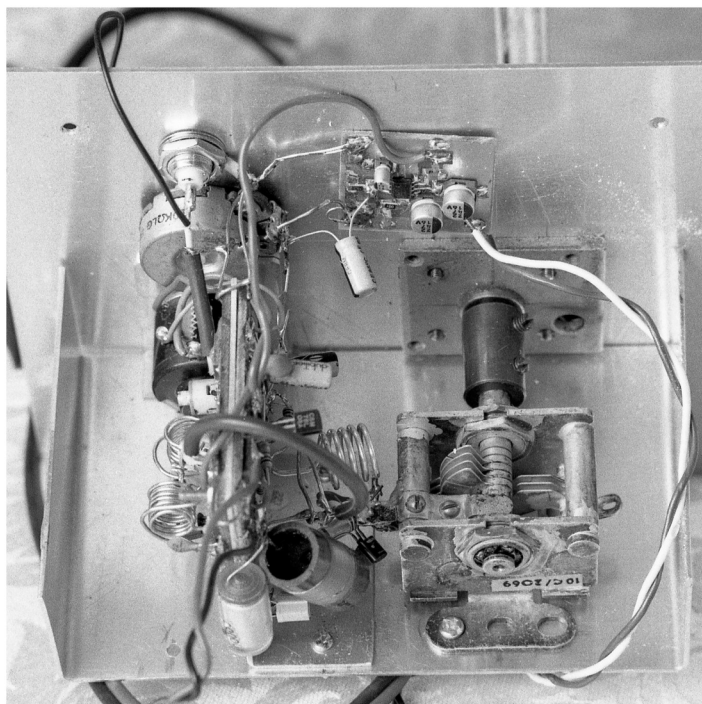

used a piece of copper clad circuit board with islands stuck on to make the component anchors for the regulator, the bias circuitry, the quench components and the audio hf roll-off filter. The detector stage is sky-wired with very short connections. The moving vanes of the tuning capacitor are coupled to the detector ground plane circuit board with a short stiff copper wire link; the FET gate is soldered to this link, as is the coupling link for the coil and the padding capacitor across the tuning capacitor. The FET drain is soldered to the tuning capacitor fixed

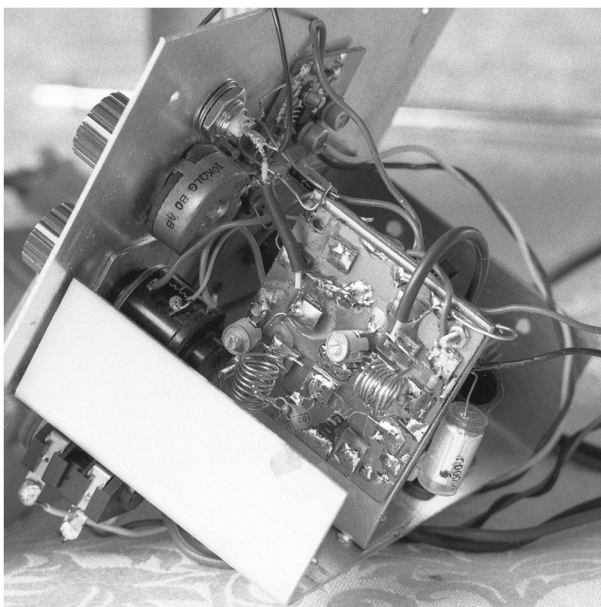

plate tag, as is the feedback capacitor, which itself is connected at its other end to the FET source where it connects to the top end of the RF choke. From the other end of the choke the wiring should be kept short and direct but it is nowhere near as critical as that at the RF end. Audio frequency and DC returns can be made to the copper clad board ground plane. The supply end of the tuning coil is decoupled to ground at the ground plane board end of the wire link mentioned above; the coil itself is terminated on a small copper clad board pad cemented to the ground plane.

You may need to make a short, direct connection from the aerial socket ground to the RF amplifier ground-plane, even if connection is already made through a metal chassis. The pictures should give some idea of the layout that can be employed: I mounted the two boards back to back on a bracket, the AF amplifier is mounted on the rear of the front panel but this is not critical and you can place it where you choose.

I have a small number of ten-turn pots that UK members are welcome to request. These may be 1k, 2k or 5K. All that I ask for is a "large letter First Class" postage stamp or equivalent by PayPal to cover postage cost. Please contact me first by email, pots will be sent out in strict request order, first come, first served!

For Sale

For Sale: Gould Advance SG200 signal generator. Covers 160kHz – 230MHz, internal AM modulation. Mains-powered but has provision for internal batteries. With handbook.

£50 o.n.o. Buyer collects (North London), enquiries to Colin G0CEU 020 8801 1415

Modifying The MFJ-901 Resistive Bridge

Graham Stannett, G4VUX

Last summer, I started operating from a local park with some friends, one of whom uses a resistive bridge to measure reflected power while adjusting his antenna tuner. In an effort to minimise number of items that I need to carry, I decided to build a similar bridge inside my old MFJ-901B ATU which requires an external SWR Meter.

The circuit of the resistive bridge is described by Ian G3ROO and Tony G4WIF at http://www.ggrp.com/resistive_swr_bridge.pdf

I made a new aluminium lid for the tuner and cut a slot for a 500uA CB type edge meter (Photo 1). I used parts from my junk box so D1 is a 1N5711 Schottky type, R1, R2 and R3 are all 51R 2 Watt metal film types and RV1 is a 50k trimmer which is set to achieve full scale deflection with 5W input and no antenna connected.

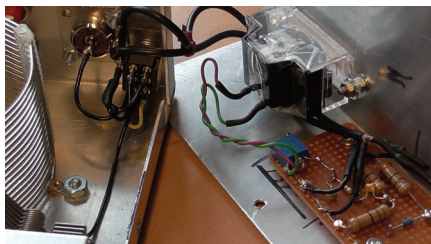

The circuit is built on a small piece of perfboard (Photo 2) and I fitted a toggle switch in the rear corner of the ATU to select TUNE or TX (Photo 3).

When the bridge is set to TUNE, the worst case VSWR seen by the transmitter with any antenna will not exceed about 2:1. When the antenna is

matched, the meter will dip to zero. The switch is then set to TX (by-pass) for normal operation. Leaving it in TUNE will introduce a 6dB loss in the signal path. We inadvertently forgot to select TX on one occasion while using an LNR 2.5W transmitter and received several good reports on Reverse Beacon Network!



The meter is not intended to indicate forward power but, with no antenna connected, one Watt gives about half scale so it can be used for QRPp applications too. The maximum transmitter power must not exceed 5W.

GQRP Club Audio Amplifier Chip TDA2822

Tony G4WIF g4wif@gqrp.co.uk

In the Autumn 2017 Sprat our club sales manager Graham G3MFJ described a new audio amplifier chip that we have in stock for members at the very tempting price of 20 pence. A search on EBay will show that you can easily pay more than a pound for one. The TDA2822 is described as a monolithic integrated circuit in 8 pin D.I.L. package intended for use as dual audio power amplifier in portable cassette players and radios. The datasheet describes how it can be configured as a single channel amplifier (bridge mode) which is likely of more interest to us as QRPers.

Over the years, simple QRP radios have utilised old stalwarts such as the LM386 and LM380 chips (which are also pretty cheap). They have always seemed a bit wimpy to me in terms of actual gain. There have been clever tweaks to improve the gain but I still wouldn't call them "loud".

More recently we've seen attempts to break away from very simple and at the sacrifice of a little more complexity we get something with a lot more "wellie" in terms of output. One example is the amplifier that Pete Juliano uses in his LBS design and has reused in his recent "Simpleceiver". This uses a combination of the NE5534 and LM380 for quite a useable amount of gain.

There is however always a quest for "really simple" and the club's recent acquisition of the TDA2822 chip perhaps fills that need. Here is the very simple circuit from the datasheet (** also on the club website). It needs just ten components as shown below.

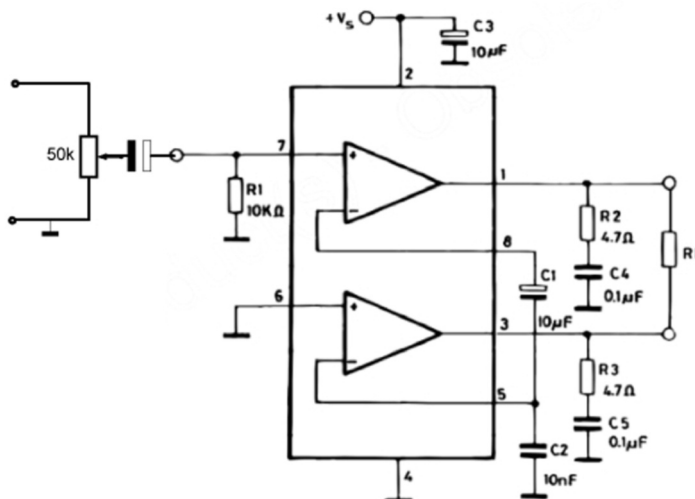

I etched a small printed circuit board to try the chip out. Really, this circuit is so simple it is ideal for dead bug construction or perfboard to be used. I just like the process of creating printed circuit boards and using the toner transfer method it doesn't take very long.

To test it I dug out an original 40m Rockmite which has a miniscule audio output. When measured, the audio signal rarely went above 40mV. With just headphones you could just about make out that there was some CW being received. [There is a new and improved version available at "QRPme.com"].

Although the datasheet allows up to 15 volt supply, early testing suggests that we are supplying a much lower voltage version. The gain produced with just 3 volt supply was quite impressive and I measured a current drain of under 10mA with an input signal. With none at all the quiescent current was in the low microamps.

I doubled the supply to 6 volts and it was louder for sure, but to my ear it didn't quite seem twice as loud. Certainly with a small loudspeaker of some two inches diameter you can hear the radio across the room. At 6 volts, the current drawn had risen to 45mA. I left the amplifier running in the shack all day with a constant background of 40m CW and I would say that for the club TDA2822 chips this is an absolute safe maximum voltage. However, given that most junk boxes probably contain a 5 volt regulator this is an ideal voltage to supply these chips while still getting a great deal of gain. Above 7 volts the chips start to get warm and they will of course expire when subjected to this kind of abuse.

My advice would be to run it at a regulated 5 volts and it will be pretty much indestructible.

One final warning. As shown in the datasheet, in bridged configuration neither leg of the output is grounded so be careful to leave the loudspeaker floating. My printed circuit board design is available at www.fishpool.org.uk/audioamp.htm Graham G3MFJ and Nick G8INE also tested the chips with the same result. Nick worked up a Veroboard layout as an alternative to my PCB.

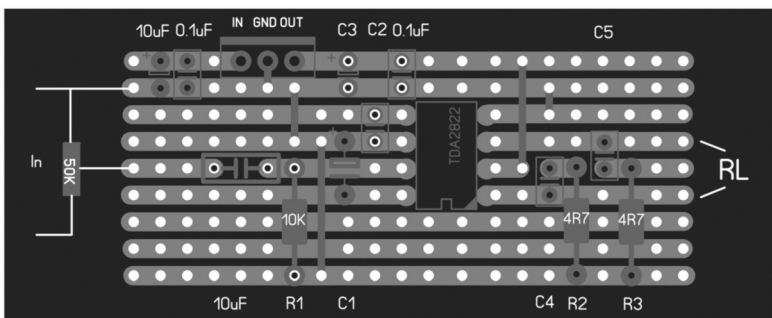

A new regenerative receiver

Olivier Ernst, F5LVG

This is a 4 bipolar transistor receiver: RF amplifier, regenerative amplifier, demodulator, and AF amplifier for headphones.

The front end capacitor has a very low value (1pF) to “avoid” transmodulation in the first sate. Two transistors are used for regeneration and demodulation. This allows to use the best parameters for each function. A Darlington transistor is used for the AF amplifier because of its high input impedance.

Two polyvaricon variable capacitors are used : 120 pF band set, 20 pF band spread (capacitor 443df). There is no reduction drive, so use big knob (56 mm diameter for the band spread).

NPO capacitors are mandatory for capacitors < 1000 pF.

A very good frequency stability is obtained because the high C of the tank circuit. The noise is very low.

Adhesive copper sheet is stuck on the inside of the front and this used as ground to solder the parts to. There is no hand capacity effect.

I made SSB QSO with this receiver on 80m, 17m and 15m.

Coils: 22 mm diameter

Band	Turns	Ct	Cp
80m	12	330	Short-cut
40m	5	470	Short-cut
20m	3	330+	5 100
17m	2	330+1	00 33
15m	2	220+	22+5 33

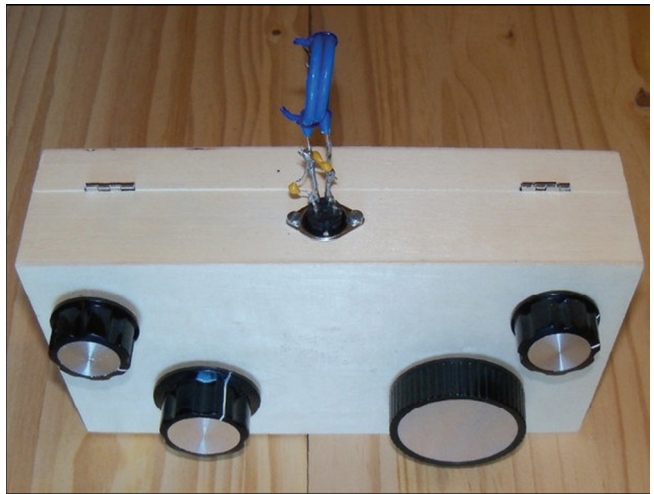

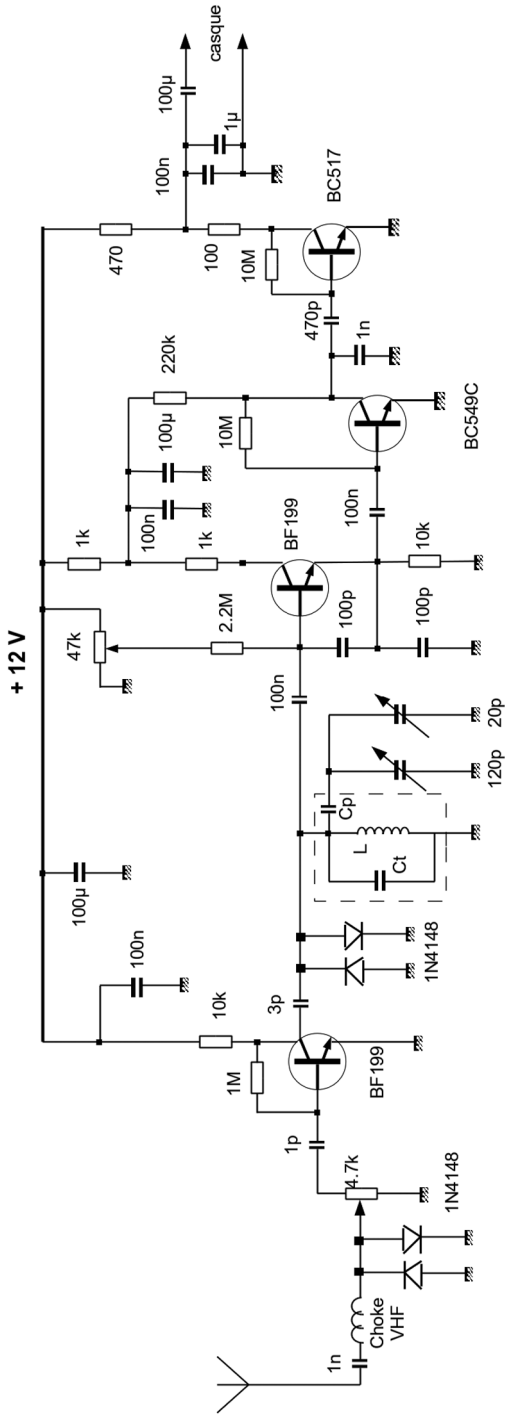

RX 80 40 20 17 15 m F5LVG 2017

Optical Coupling?

Richard J. Constantine G3UGF

No, you're not seeing things; they really are antennas passing through a window!

Modern houses with UPVC, sealed windows are really a curse on Amateur Radio. The shack may be warm and snug, but there are very few options for cable entry. Do I drill a hole through the wall with a pipe cutter and risk bridging the cavity wall? Do I come in under the roof overhang or drill a hole in the ceiling and risk birds, wasps or bats in the loft space?

Having moved from a large, older property where I had constructed my own wooden window frame, I was at something of a loss moving to a newer house with fully sealed UPC windows. I toyed with the idea of drilling through the plastic window frame, but was unsure if I might clip the glass and break it.



Investigating further, I discovered that sealed double-glazing units are held in place by curved beading that unclips easily with a special tool, similar to a paint scraper or putty knife. Contrary to popular myth, the sealed units are not Nitrogen filled. They are just two, pieces of glass frame sealed in warm, dry environment.

A local glazing company agreed to my unusual request to produce a duplicate unit using Perspex and also to drill 4 identical holes in each pane, before assembly. – Cost £80.00, including installation. Three Winters have resulted in no condensation issues, but in any event could presumably have been solved by introducing a small quantity of Silica Gel into the unit.

Rubber blanking grommets, (Halfords) seal the holes when not in use, or with small holes cut to size, allow cables to pass through as required.

Repeating the exercise, I would ask for slightly larger holes, 12-14mm each and spaced a little further apart, to avoid possible cracking and I really should have asked for one more hole than I planned!

There you have it, a simple, non-damaging solution to a tricky problem.

Antennas Valves and Vintage

Colin Turner G3VTT 182 Station Road, Rainham Gillingham,
Kent ME8 7PR g3vtt@aol.com

The Winter Sports is upon us and we've just had another successful Valve QRP Day in November so another year is about wrapped up. My thanks to those of you who keep the GQRP 60m net going on 5262 KHz and come on the air regularly.

The constructors are still out there and G4GDR and G3YVF have been experimenting with a battery valve transmitter to match their Eddystone AW2 regenerative receivers they have made. The PA valve is an ATP4, (Army Transmitting Pentode type 4), which is a pre WW2 device still around and available and was used in the Wireless sets 22, 38 and 68. A word of warning, it is a 'Mazda Octal' valve and will require a special valve base which is rare. The valve looks like an International Octal type but it will not fit that socket. Even experienced constructors have made the mistake of trying to plug a Mazda valve into an IO base so you have been warned! I never ceased to be amazed at the number of antique components you can find on E bay not to mention the rallies that still cater for constructors wishing to try these old reliable vintage circuits. G3YVF writes:

You probably are aware from Adrian that I have built a co/pa transmitter using the ATP4 battery valve which was good for 300mW in some WW2 man pack transmitter receivers. This valve is capable of a lot more RF. I usually get between 3 and 4 watts RF out from it on 5 MHz with 150v HT at 50 to 60mA anode current. I drive it with a four pin triode type HL2K and the transmitters covers Topband to 40m without any trouble. The circuit has two valves, two tuning capacitors, two resistors, two coils and two capacitors. The ATP4 needs 2.6v at 300mA DC for its filament supply and if you don't trust a regulator as it may fail short circuit and blow the heaters, this is how I supplied the heaters in a fail safe way. The HL2K needs 2v at 100mA and that is easy using a 5.6ohm resistor from the 2.6v supply developed by the power supply.

Here is a drawing of the transmitter designed to match the Eddystone 1936 All World Two receiver and a picture of the transmitter etc. Not shown but note the key is in the HT line to the PA and the oscillator is switched on in transmit by a switch and this gives a netting signal as well changing over the antenna. As there are so few parts in this little transmitter has earned itself a name, the 'Skeleton' rig so I've cut out a skull and crossbones to fit under the lid with its name which is fitting as the anode top cap is live!

Geoff and Adrian inform me the circuit will oscillate with just about any crystals they have, particularly the club crystals, and the output power is really quite surprising for a battery valve. Particular attention has to be paid to voltage supplied to the filaments and smoothing so a stabilised supply with more than adequate smoothing has been devised using a pair of bridge rectifiers giving 2.8 volts output. The circuits could be quite easily adapted for other voltages and valves'

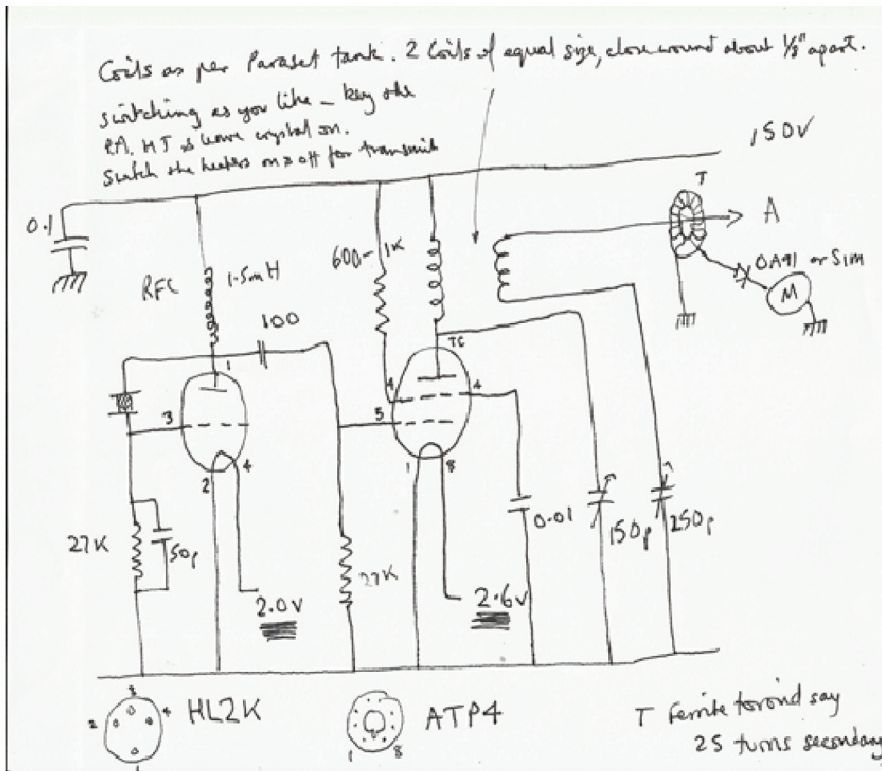
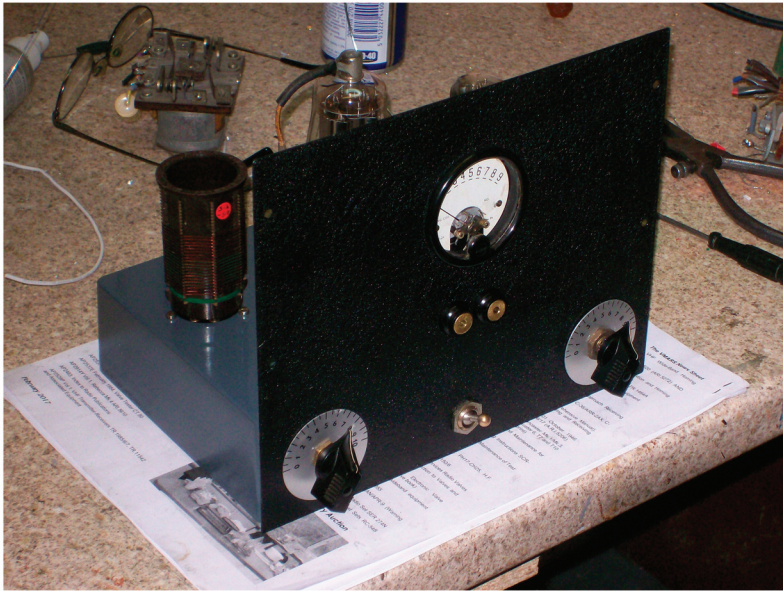



Two heavy duty bridge rectifiers across the output to clip the volatage at 2.8v (4 x 0.7v). If the both legs of the bridge rectifiers go o/c the voltage off load can rise to 4.3v approx in this example. The secondary winding is wound to produce the required dc output on load. Off load the output volatage rises to 2.8v but not above this. Thus this psu output cannot rise high enough to blow any directly heated valve filaments. This psu should never fail in service damaging valve heaters. This circuit is used to heat the filament of an ATP4 transmitting valve at 2.6v dc.



The coils are Raymart 4 pin types but that is not critical. You can make your own on a glass valve base or similar. (*What! – breaking valves?*). The two coils on the one former with a 1/4" spacing between them in the middle. It depends on your coil diameter but for a 1 1/4" diameter tube the dimensions are roughly 7t/7t solenoid wound 1/4" gap between coils, 12t/12t solenoid wound 1/4" gap between coils, 23t/23t solenoid wound 1/4" gap between coils 36t/36t solenoid wound 1/4" gap between coils. These dimension give you the four lower LF bands and are all wound with 0.75mm wire diameter approximately although this is not critical

Making Simple Ladder Line

Cristiano IZ3CQI has sent details of a simple way of making open wire ladder line. You will need to cut out the terminal blocks; we called them 'choc blocks' many years ago, with a sharp knife - so watch your fingers. You will need them at a later date for operating your Morse key. The Ladder Line is an old but effective way to transfer RF power at low losses despite the impedance mismatch. Commercial ladder line tends to be expensive and homemade line is tedious to make. One possible solution to assemble quickly and easily a ladder line is to use head-to-head wire terminals, of proper size, in the way shown in the picture. Ordinary electrical wire is used which is PVC insulated and inserted in the terminal holes. Don't peel the insulation as the screws need to be tightened just enough over the PVC insulation so that the each terminal block stays in place. Wire terminals could also be easily used to run balanced lines on walls. If walls are made of bricks or stones usually the RF power absorption from the line is very negligible and there is no substantial disturbance affecting a ladder lines performance in terms of attenuation. There is no need also to keep the wires rigorously at a prescribed distance each other. The closer the wires the less the line properties depend on presence of objects in the vicinity and the clearance between the wires is also not critical. 'Choc block' wire terminals are such that a ladder line made with them would have relatively low impedance, in the neighbourhood of 100 ohms or so. 72 de Cristiano, IZ3CQI GGRP 10529



That's it for 2017! I have one or two articles left for next year so please let me have your articles, preferably written in Word, and any diagrams about your aerial experiments and construction, valve circuits and nostalgia radio. I would to thanks those of you who kept the 5262 Kc/s net going in the Summer and Autumn and who have continued to support QRP by building and operating equipment in 2017. I look forward to working as many of you as I can during the Winter Sports and I would like to take this opportunity to wish you all a Happy Christmas and a Prosperous New Year but most of all a healthy 2018. (I have it on very good authority that two CW contacts a day will stimulate the brain and prevent to onset of dementia).

Valve QRP Day November 2017

Colin Turner G3VTT

182 Station Road Rainham Kent ME8 7PR

G3vtt@aol.com

The GQRP Valve QRP Day actually lasted the weekend with stations active on both days. As usual there was the inevitable contest with stations spread all over the place and the QRP stations could be easily identified by the passing of accurate reports and not 5NN! From G3VTT I worked GW3UEP and G4ZXN on 60m which was a bonus plus G3XIZ, G4GIR and G3UD with QRP to QRP QSO's on 80m plus some other non QRP stations. The little 12A6 transmitter did very well again and its valve black screening can was pleasantly warm after a whole days operating! G4GDR was active with his 6L6 transmitter on 60m working GW3UEP. Guido HB9BQB was QRV using this homemade transmitter and a drain pipe used as an antenna tuned by an SGC237 ATU. It uses an EF94 and 6V6 combination on 80 and 40m and the circuit will be published in a future AVV.



G3XIZ has sent some comments. 'It was a real mixed bag of a Valve Weekend this time. I 'jumped the gun' and had a few QSO's on the Friday so my score of valve rig QSO's was up a bit on the last time. I managed 32 QSO's with 18 separate stations, 14 QSO's with 9 stations being 'valve to valve'. I unfortunately missed (yet heard) some of my regular customers but

worked two new ones for me: G3ROO and G3INZ. Apart from the usual chaps I worked 4 German stations and the Yorkshire Air Museum station who answered my CQ on 80m. M0FMT called me on Sunday morning using his valve MF TX but unfortunately my valve rig does not cover MF so I had to answer him using my solid state kit. Needless to say 40m was yet again wiped out by the 599 Contest Brigade as was 160m on Saturday evening with a powerful station sitting on the QRP calling frequency. Your published suggestion of a mid-week activity period has merit if we can find a contest-free couple of days. I heard / worked more valve stations this time than previously which is most encouraging. A couple of my local pals M0JXM and G4FGJ are hoping to take part next time and they always support me on valve days.

Not wishing to 'police' the event but maybe a gentle reminder is in order of the 'gentleman's agreement' to clear the **QRP** calling channel for a few minutes (unless called) after each **QSO** to give other stations a look in. The 80m **QRP** channel can get quite congested, especially during valve events. It has the Korean BC station carrier sitting on it and an SSB fishbone type station occasionally comes up. I think there's a case for us valve chaps encouraging another frequency to supplement 3560 Kc/s, maybe slightly higher up the band to clear the contest sub-band. Could **GQRP** possibly source some crystals around say 3563- 3565 Kc/s? (Any ideas Graham?). Many thanks for organising the event'. **Derek G3NKS writes:** 'I made 10 QSOs all on 80m. Stations declaring the use of valve TXs included **G3ROO** (WS48 set), **G3TYB** (CO/PA), **G3XIZ** (CO/PA), **G4ZXX** (AT5 and Paraset). As usual I was using a CO/PA using a couple of 6V6s, a Drake 2-C RX and a G5RV at 15ft. Time for radio was limited as the weekend clashed with birthday celebrations – mine! Looking forward to the next event.⁷³ **Derek G3NKS PS** With so many of us being crystal controlled on 3560, I wonder if after calling CQ/QRZ we should subsequently let the responding station have the frequency so that each of us gets a reasonable opportunity to use the frequency rather than having to wait for the first station to QRT or QSY once they've run out of others to work. In other words, let's take it in turns to call CQ on 3560. What do others think?' From **G3TYB** 'I didn't have a great deal of time over the weekend but worked G3XIZ, G4ZXX and G3NKS on 80m. For Sunday evening I decided to give 160 a try, and had a very satisfying QSO with G4GIR in Bedford. Seemingly on a roll I then managed to work SM7FCU, again on 160. My rig was the Mark 119 spy transmitter (CO/PA) running 5 w and an Eddystone 830 receiver. The antenna was 300ft LW'.

Well that's it for this time. The next Valve QRP Day is again a two day event on April 21st and 22nd There are contests planned but we will have to battle through as usual. I agree with Chris G3XIZ and G3NKS's comments and would make the following suggestions:

1. Call 'CQ VQRP' on or around the QRP frequencies.
2. When receiving always tune HF and LF as there may be somebody calling you off frequency.
3. After a QSO pause and allows others to work the station. Let's be gracious and gentlemanly about operating.
4. Please get any photographs and reports in promptly to me. I still get reports after the date for copy.

Thanks to you all for keeping home construction and CW operating alive in 2017 and let's see if we can carry on into 2018 with the Winter Sports.

MEMBERS' NEWS

by Chris Page, G4BUE

E-mail: chris@g4bue.com



Members continue to show their sadness at the passing of **GM30XX** reported in *SPRAT* 173. **GØEBQ** writes, "So sorry to hear about **GM30XX**. There's nothing to say that hasn't been said. My **OXO** was my first QRP rig from back in the 1980s, I've worked the USA with it, and got it out again the other day as a sort of tribute to George and had a solid two-way QRP QSO with an OH station. **G3XJS**, whilst commenting on the low level of activity and poor conditions in the Winter Sports, said, "George, **GM30XX**, (RIP) always said that we can do nothing about poor band conditions and that we should just go on the air and do our best to make QRP QSOs. That is as true today as the day George said it!". I agree.

G4GIR has constructed three QRP Labs QCX transceivers for 30, 20 and 17m. Ian says he had a few problems but otherwise all went together well, and he has been using them on WSPR with some good results on 30m. He has incorporated an AGC mod and a variable power output control from 0-6W. He says, "When band conditions recover, I am hoping to get some CW QSOs on 17m". **G3XGY** asks, "I know there is no Foxx-3 kit for 17m, but I have the xtals. Does anyone know if it's been attempted, possibly with a modified 20m version?".



GØXAR has also made the 30m version of **GØUPL**'s QCX kit which he says is a very good project despite making a couple of mistakes, nowadays known as learning points! He says Hans has now published a comprehensive fault finding guide on his website. Steve had planned to take the radio with him on one of his regular trips to Budapest in February, but ran out of time to test it. While in Budapest he visited Mikrovill, a component shop a short walk from the Deli Railway Station <<http://mikrovillkft.hu/>>. Steve says they have a wide range of stock including valves and hard to find articles, and the prices are reasonable. He bought a brand new triple-gang variable capacitor in a shielded box with a slow-motion drive for £1.50. The snag is that the staff don't speak English, so any visitors should take a picture of what they want, or a paper and pencil!



Welcome to new member **MØRON** who describes the *SPRAT* CD as, "Excellent CD, full of good ideas and well worth the paltry cost". Andy was planning to warm up his soldering iron after Christmas. Welcome also to 85 year old new member **GØTUJ** who is 'stone deaf' except "to the sweet strains of Morse". Walt was looking to be QRV with a 1-5W CW rig and indoor antenna. **G3JFS** suggests looking at the Reverse Beacon Network (RBN) after

you have sent a few CQ calls and you could be surprised at the places your signals have reached. Peter writes, “Sadly the days of working the world with 5W and a bit of wet string are gone for the foreseeable future”. Enter your callsign on the RBN at <<http://www.reversebeacon.net/srch.php>>.



IW1PAG read in *SPRAT* about the ‘valve days’ activities and is preparing to use these old ‘warm’ technologies. Dorianio doesn’t have a valve transmitter but has a Trio 9R-59DS valve receiver in good working condition and will arrange it with the wonderful (for him) old Yaesu FT-767GX transmitter and the ‘Extern Receiver’ function to commute to the Trio receiver. He intends to build a simple valve transmitter, but at the moment says that if he contacts someone, it will not be complete but ‘half valve’ equipment!

MIKTA took part in the RSGB AFS contests on 40 and 80m in January which has large contest groups and lots of high power stations taking part. Dom heard quite a few G-QRP members calls in both the CW and SSB legs. Although conditions were reported as ‘terrible’ the leading QRP (10W) station in the CW leg, **G3SWC**, made 169 QSOs, and the runner-up, **MØRYB**, made 160. There were 18 QRP entrants and Dom made 56 QSOs with his 40m GP and 80m dipole at 50 feet as the sole G-QRP Club entrant. There were 19 QRP (10W) stations in the SSB leg results and **G3SWC** was again the winner with 151 QSOs and **G3KAF** runner-up with 146. Dom made 46 QSOs, again as the sole G-QRP Club entrant. The 2019 contests will be on 6 (CW) and 13 (SSB) January. Why not consider joining Dom in making up a full G-QRP Club team in 2019? There can be a maximum of four stations in each team.



The above photograph shows CQ Scotland Group’s ‘Kits for Kids’ project <<https://www.cqscotland.com/>> in progress at Hamilton on 23 January. **MMØHQD** has been buying components from Asia recently and bagging them up into small electronic projects for the Group, who then give them away to the parents of local kids as an introduction to the hobby of electronics and amateur radio. David asks if members would consider helping, so more kits could be sent more widely around the UK? David, writes, “Here’s how members

could help: 1. Send us components you no longer need, a 'Components Wanted List' is available on request. 2. When next placing an order for parts, you order items that are on our 'Components Wanted List'. If this way of promoting a hobby that we have been enjoying for many years appeals, please do get in touch. Let's see what we can achieve together!". David's email is <davidmm0hq@gmail.com>.

In a later email David thanked all those member who contacted with offers of surplus components to be passed along to the young builders! He will be on stand 13 and 14 (next to the G-QRP Club) at the Glasgow ASRA Rally on 20 May, and says all are welcome to drop by for a chat and hand in components no longer required. I think this is a wonderful project and one of the best I have heard of to encourage young people into our hobby. The project is supported by the RSGB and I hope other amateur radio clubs in the UK will follow the idea. From a personal point of view, it has solved a problem for me! After 21 years at this QTH my wife and I have decided to 'downsize' to a smaller QTH later this year, and I am in the process of sorting through all the radio equipment and components I have accumulated since 1973 when I was first licensed. I was wondering what to do with everything I won't need and now have an answer for the smaller components!

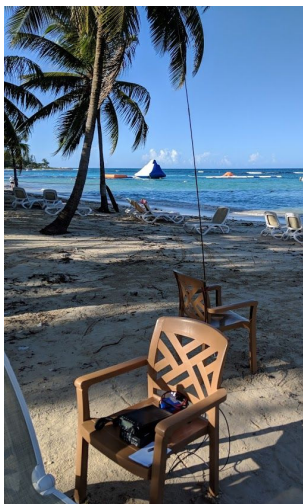

The photograph far left shows **VE3IPS**'s lovely operating position as **6Y5IPS** in January, practising beach-side SSB operations in Jamaica. John managed a few 40m contacts for Winter Field Day and worked EA8 on 20m SSB with 10W with the Yaesu FT-891 and 10 feet vertical coupled to a Chameleon Hybrid Micro balun,

(second photograph). He also used the Packtenna Mini 1:1 balun with a homebrew SOTA style linked dipole. John writes, "Band conditions were horrible but the bottled Guinness Stout was not! A passerby asked, 'Are you busy on the short-waves?' and so I made new friends and learned how to play Rummikub with UK visitors from Kent. Only the UK would use the term 'short-waves'!"

G3JFS has experienced every sun-spot cycle since 1947 and says there is no doubt that this one is by far the worst and, if current predictions are correct, it will be a long time before sun-spot cycles get any better. At times, Peter says he is finding it difficult to have meaningful QSOs with QRP and often has to be content with a few 5NN rubber stamp type contacts. In 2017 he made over 900 QRP contacts with 88 DXCC, 77 on CW, 54 on SSB, 44 on RTTY and 37 on other data modes. This year, as at 10 February, he has over 100 QRP contacts with 32 DXCC on CW, largely the result of taking part in NAQCC and Club 72 activities. Peter suggests the moral is to get on and operate no matter how bad things might seem (echoing the words of **GM3OXX** in my opening paragraph).

GØEBQ's latest project is the suitcase radio (shown on the top of the next page). Nigel is calling it a 'nod to the Paraset' rather than an attempt to copy it exactly. It is solid state based on **KD1JV**'s MAS-80, built in an evacuee's suitcase (according to the *eBay* seller!) with a built in ATU based on the club kit, a pair of SG Brown phones dated 1940, and an ex-WD key and vintage Eddystone knobs. Nigel says, "Our club is in the process of building a shack in what was the old Martlesham airfield where Douglas Bader was based and I

hope to use it on open days there with a battery and throw-out antenna as a totally portable unit. I do find QSOs hard to come by since, although the regen receiver is very sensitive, the crystal controlled TX is invariably off the frequency of the station I want to call! His next project is a valve rig.

Earlier this year, **5B8DA** says the designer of the BitX20 put plans up at <<http://www.phonestack.com/farhan/ubitx/ubitx.html>> for a 3-30MHz TCVR, and has now announced a kit with populated boards available for \$109. Paul says the website at <<http://www.hfsignals.com/>> says it is, "A fully tested and tuned μ BITX HF TCVR board (6 x 5½ inches). The Raduino board with display for menu access, three audio sockets for the mic, earphones, and keyer. A high quality BNC antenna connector and power supply connector". He says you have to supply your own enclosure, PSU, microphone case and speaker to complete the radio. Paul adds, "I might give it a go after I've received and built my QCX".

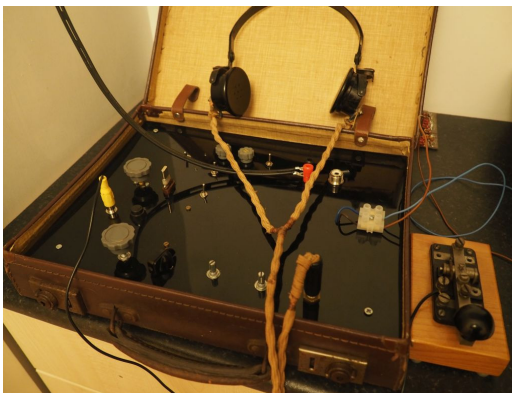

DDØVR planned to be in the Caribbean in December and January and hoped to be QRV 17/31 December from Barbados as **8PØVR**, 31 December/10 January as **FM/DDØVR** from Martinique, 10/14 January from Dominica as **J7ØVR** and 14/20 January from Guadeloupe as **FG/DDØVR**. The photograph left shows Heli's travelling equipment, consisting of KX3 + HL-1.1KFX 500W for SSB QRO and KX2 + Begali Adventure, 5-10W for QRP. Antennas are Hyend <<https://www.hyendcompany.nl/>> 20-40m 4kW, multiband 800W and a mostly self-build quad for 20, 15 and 10m if space. **W2APF** is QRV 17 February/14 April as **CT/W2APF** from Castro Marim, Portugal. Thaire will use a KX3 and wire antennas and operation will be 'holiday style' on whatever bands are open, and he, "May even get up the courage to try FT8!". **M1KTA** will be QRV 10/11 March for the BERU Contest, and a few days after, as **C6AKT** using homebrew equipment (even the PSU) with a K2 and a ATS-3B. Antennas will be a 20m VDA, four-square on 40m and two-element on 80m. Dom hopes to QSO UK QRPers.

RV3GM experimented with a 75mW output one transistor TX in January and on some days managed two to four QSOs using a two-el wire beam antenna on 14060kHz +/- V XO. To identify he was using less than 100mW, Oleg offered code QRPx. He says, "Currently there are 50 QRPx QSOs in my log with 19 DXCC, the best being **G3XJS** near London. Peter used QRP 3W to a Hexbeam. I am often active QRPx in the 'Rendezvous' QRP roundtables on Tuesday, Thursday and Saturdays at 1200z on 14060kHz and happy for QSOs".

G4GIR has acquired a very fine condition AR88 serial no 00726 that belonged to **G3IYY** (SK) who, according to **G4AQS**, acquired it from **G3INN** who bought it back to G from DL. The photograph top right of the next page shows it in **G3IYY**'s shack. Ian says it powered up and appeared to work fine, however it wouldn't peak on Range 2 and investigation

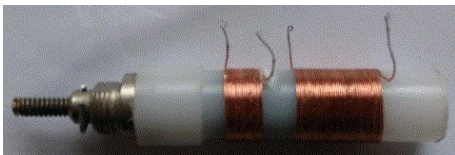

found the Range 2 antenna input coil had melted, RF into the front-end he would guess. The photographs above show the original, and Ian's re-made Range 2 coil former below. All the bathtub capacitors have been re-stuffed and the 'horrid' micamold capacitors replaced. He just now needs to get hold of an SSG to sweep the IF's and perform a full alignment.

GØEBQ has just finished the Skeleton TX from *SPRAT* 173 (page 29) with the space charge 12v RX, just about to test drive it. Nigel says, "It is a real bad boy!" and thanks **G3YVF** the author for all his kind advice. **GØXAR** is learning 3D printing so he can make his own project cases and other radio things. Steve made his own printer from a kit, and says it was, "A bit like *Lego* for grown ups"! At the beginning of February **W4OP** said he had a pretty much complete kit of the Hands Electronics RTX-10, except for any information on the front panel board, documents or schematic. "Can anyone assist?", he asks. Dale can scan and post other module manuals if anyone needs them. His email is <parincl@frontier.com>.



At the beginning of February **2E1HFH** asked for advice on the G-QRP mailing list to build a BFO. **G4DBN** suggested a CMOS hex inverter like a 74HC04 in a DIL14 package, see <<http://electronbunker.ca/eb/SignalGen455.html>>. Neil said if you want to trim the frequency, it might need a variable cap from one leg of the resonator to ground, and to look on ExtremeCircuits for the details. He would ditch the zener and R6 and power it from a three-terminal 6V regulator. Neil built the 74HC04 version using dead-bug technique on a bit of PCB offcut soldered into a tiny tinplate box. **G300U** says a CMOS oscillators may be very convenient in terms of component count but they can generate a lot of harmonics. A JFET Pierce oscillator does not require a lot of components and should be reliable in operation from a 6-9V supply but, as a high impedance device, it will require some form of buffering to connect to an external circuit.

Thanks to the contributors to this column. Please let me know how your spring goes for the Summer 2018 edition of *SPRAT*; what you have been building, who you have been working, and any other information about QRP, by 10 May. Also, interesting pictures, please don't be shy in letting members see what you have been building and/or where you have been operating from, your antennas, who you have been meeting and even a shack picture to let other members know what you and your equipment look like. Let me know if you intend operating from somewhere other than home during the summer and autumn months so I can let members know to listen out for you.

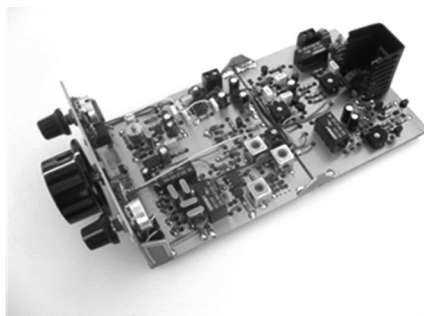

Wide range of analogue kits

Low cost, adaptable, & simple style

Regen TRFs for beginners and simplicity

Direct Conv RXs, Xtal/VFO CW & DSB TXs

Superhet RX and TCVRs, phone or CW

Accessories – Counters, AMU, AGC, etc

Walford Electronics Ltd

Upton Bridge Farm, Long Sutton, Langport, Somerset TA10 9PZ

Visit www.electronics.walfords.net



NEW

WSPRlite Flexi

Now covers 6m to 630m!

- Spot DX openings
- Test antennas
- Learn about propagation

Just connect a WSPRlite to your HF antenna and get ready to be **amazed** at what it can do when used with the DXplorer.net data analysis system.



www.sotabeams.co.uk

01625-501643

Prices exclude p&p. We ship Worldwide

CUMBRIA DESIGNS

New - The 2-Tone kit

The 2-Tone uses digital synthesis techniques to generate a low distortion composite test signal for evaluating the linearity of SSB transmitters. In addition to dual tone mode, single tone operation supports audio pass-band testing. An easy to construct kit using through hole parts, suitable for all skill levels.

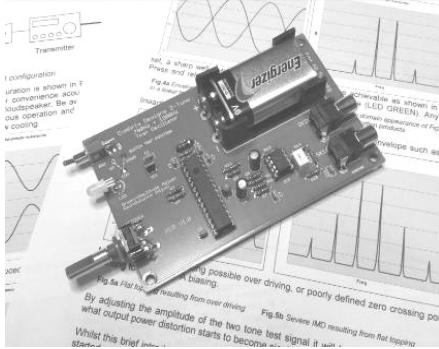

- Composite 700Hz and 1900Hz output
- Variable single tone mode 100Hz to 3500Hz
- Output adjustable in 1dB steps over 40dB
- 0dB and -20dB RCA outputs nominal 600 Ohms
- Adjustable balance in 0.1dB increments
- Harmonics better than -55dBc
- Settings may be stored to memory
- Rotary encoder control
- Three colour LED status LED
- Powered by a PP3 battery (not supplied)
- 4V to 13.2V operation at 15mA typical
- Designed to fit a Hammond 1455 case
- 2-Tone dimensions 120mm x 75mm x 25mm

Order on-line at www.cumbriadesigns.co.uk

Bowood Electronics Ltd

Suppliers of electronic components

Batteries, Buzzers, Capacitors, Connectors, Diodes, Cases, Ferrites, Fuses, Heatshrink, IC's, Inverters, LED's, PCB, Potentiometers, Power Supplies, Presets, Rectifiers, Relays, Resistors, Soldering Equipment, Stripboard, Switches, Test Meters, Thermistors, Thyristors, Tools, Transistors, Triacs, ...

Catalogue available NOW Please send 60p stamp or visit our website.

Website: <http://www.bowood-electronics.co.uk>

email: sales@bowood-electronics.co.uk



Mail order only - NOTE NEW ADDRESS
Unit 10, Boythorpe Business Park, Dock Walk,
Chesterfield, Derbys, S40 2QR
UK Telephone/Fax: 01246 200222

www.SDR-Kits.net - Visit our Webshop!

New – in stock! – CS40 40M & CS20 20M SSB TRANSCEIVER KITS

Now with full Synthesized VFO band coverage - Ideal for WAB, /P or SOTA Operation

Fun to build – complete kit all leaded components except 1 SMD part – Printed Assembly Manual

*Fun to Operate: 0.5uV Sensitivity and 10W RF Out 40m, 5W RF Out on 20m 12V- 13.8V DC
Export price including Speaker Microphone £128.50, Price incl VAT UK/EC £154.50 + Shipping*

PA0KLT Low Noise Synthesized VFO kit with LCD display uses high performance **Si570 ICs** covers 3.5 MHz up to 1417 MHz. Great for homebrew VFO or LO Projects - Signal Gen etc

DG8SAQ USB-controlled Vector Network Analyser VNA covers 1 kHz to 1.3GHz - *In stock Assembled and tested as reviewed Radcom Nov 2011 - Calibration Kits - Details on Webshop*

Si570 ICs – Si570CMOS 200MHz only £10.50, Si570BBC 280MHz £15.50 Si570DBC £18.50 all + VAT
Mitsubishi RF FETs stocked: 175 MHz RD16HHF1 £4.50 RD06HHF1 £3.75 RD00HHS1 £0.95 +VAT

SDR-Kits, Office 11, Hampton Park West, Melksham, Wilts, SN12 6LH, UK Info@sdr-kits.net

Rig Broken or needs alignment?

Commercial/Homebrew equipment repaired & aligned

Ten-Tec repair specialist, spare parts ordering service available

Adur Communications

13 Dawn Crescent, Upper Beeding, Steyning, West Sussex. 01903 879526

Unadilla baluns & traps - Outbacker Antennas

www.adurcoms.co.uk

AMTOOLS UK

www.amtoolsuk.com Virtual Amateur Radio Emporium!

Web site recently updated.

Bargains in tools, components and antenna hardware

Favourites include fibre glass poles, Springy (Slinky element),

FAST-TRACK instant PCB tape, popular QRP devices such as ADE-1 and SA602A.

variable capacitors, magnifiers, PCB drills and lots more.

Low prices and low postal charges worldwide.

email enquiries welcome. (amtools@ntlworld.com)

72, Les. G4HZJ Tel. 01942 870634

1 Belvedere Avenue, Atherton, MANCHESTER, M46 9LQ

QSL Cards from Nasko - LZ1 YE

LZ1YE has sent me details of some attractive QSL cards including the Club Log.

Members can make their orders by sending samples, explaining what they want to print, and sending the materials: photos, files...etc via e-mail: qsl@qslprint.com or qsl@kz.orbitel.bg or if no internet access via the postal address: Atanas Kolev, P.O.Box 49, 6100 Kazanlak, Bulgaria. Examples of cards and prices can be seen at www.qslprint.com

For people need QSL cards urgently LZ1YE dispatches three days after the payment is made. UK

Members can pay via a UK address: Please send your cheque / cash via recorded delivery to: LZ1YE QSP Print service, c/o Melanie Rowe, St. Leonards House, 35 St. Leonards Road, Exeter, EX2 – 4LR, Devon. e-mail: m0mja@aol.com (make cheques payable to : Melanie Rowe)

KANGA PRODUCTS



**Radio Kits and Electronic
Components for the
Radio Amateur**

***** Official UK/EU Distributor for LNR Precision *****
Mountain Topper 3 & 5 Band CW Transceivers
4SQRP Kits in Stock, "URMSTON" Regen Receiver
Acorn II SDR Receiver, SMD Kits, KANGA K16 Keyer
DX 40m Receiver incl LCD Readout, Sandford Wattmeter
P&P (UK) £4.40 Euro Zone and DX Email for details

www.kanga-products.co.uk

sales@kanga-products.co.uk

Telephone: +44(0)1942 887155 Mobile: +44(0)7715748493

Kanga Products, 142 Tyldesley Road, Atherton, Manchester M46 9AB

QRP Labs

Kits & modules for QRP enthusiasts!

NEW! QCX mono-band 5W CW tcvr kit!

- Available for 80, 60, 40, 30, 20 or 17m
- CW Decoder, Iambic keyer
- Easy all through-hole component assembly
- Comprehensive 138-page manual
- High performance receiver, 200Hz CW filter
- Full or Semi QSK operation
- WSPR and CW beacon mode
- Preset frequencies and stored messages
- Rotary-encoder tuned VFO with A, B and Split
- BUILT-IN test equipment (DVM, RF Power, Freq counter, Sig Gen) for alignment and testing – NO additional test equipment required!
- And more!

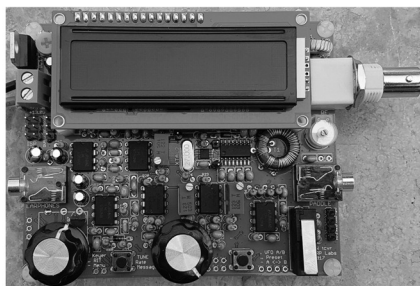

Only \$49 / £38 / 41€ See <http://grp-labs.com/qcx>

Order online at <http://grp-labs.com> using PayPal.

Note: prices are based in US \$. Prices shown in £ or € are correct at time of writing but will vary depending on exchange rate fluctuations.

QRP Club Sales

Graham Firth, G3MFJ, 13 Wymore Drive, Bramhope, LEEDS. LS16 9DQ

Antenna Handbook – 2nd edition – members price £6.00 plus post	} £2.00 (UK) or £5.50 EU
Radio Projects volumes 1, 2, 3 & 4 – by Drew Diamond – members price - £6 each book + post}	} Or £8.00 DX <u>per book</u>
6 pole 9MHz SSB crystal filter (2.2kHz) £12 plus post (max of one)	} £3.50 (UK); or
Polyvarion capacitors – 2 gang (A = 8 to 140pF, O = 6 to 60pF) c/w shaft extension & mtg screws - £1.75 each	} £3.80p (EU); or
– 2 gang – (both 8 to 285pF) c/w shaft extension & mounting screws - £1.75 each	} £4.50p (DX)
A Pair of LSB/USB carrier crystals HC49U wires - [9MHz ± 1.5kHz] £4 pair	} All components
HC49U (wire) crystals for all CW calling freqs – 1.836, 3,560*, 7,015, 7,028, 7,030* 7,040, 7,045 7.122, 10.106, 10.116*, 14,060*, 18,086, 21,060, 24,096 & 28,060 all are £2 each	} plus postage
HC49U crystals- 1.8432, 3.5, 5.262, 7.0, 10.006, 10.111, 11.5, 14.0, 22.0, 29.0MHz – 50p each	} (ANY quantity)
HC49U crystals – 2.00, 3.00, 3.20, 3.579, 3.6864, 4.0, 4.096, 4.1943, 4.433, 4.5, 5.0, 6.0MHz 7.2, 7.6, 8.0, 9.0, 10.0, 11.0, 12.0, 13.50, 15.0, 16.0, 18.0, 20.0, 24.0, 25.0, 26.0, 27.0, 28.0MHz 28.224, 30.0, 32.0, 33MHz – all 35p each (Some of these are low profile)	} £1.20p (UK), or
Ceramic resonators – 455, 480kHz, 2.0, 3.58, 3.68, 4.00, 7.37, 14.32 & 20.00MHz – 50p ea.	} £3.50p (EU)
Diodes - Schottky signal diode – 1N5711- 20p each; 1N4148 GP Si – 10 for 10p	} £4.00 (DX)
Varicap diodes - MVAM109 – 40pF @ 9v, 500pF @ 1v. 50p each	} Post free
– BB204 – twin diodes, common cathode, 15pF @ 20v, 50pF @ 1v 50p	} if ordered with
SA602AN - £1.50 (note – I may supply NE or SA, 602 or 612 as available. All are <u>fully</u> interchangeable.)	} with heavier
MC1350 - £2.00 These are getting in short supply now so max of 2 per member	} things
LM386N-1 - 4 to 15v, 300mW, 8pin DIL - £0.45, LM386M-1 SMD – 35p	} like binders,
TDA7052A - 4.5 to 18v, 1W 8pin DIL low noise & DC vol control – £0.60 each	} toroids
TDA2003 - 10w Audio amp 5pin – £0.25 each	} polyvaricons
TDA2822 - 1.8 to 15v stereo amp – can be bridged. 0.5W Audio amp 8pin DIL – £0.20 each	} or filters
TA-7642 Radio IC – direct equivalent of MK484 (& ZN414) – 75p each	} Use just
2SC536 transistors (npn) fT – 100MHz, hFE-320, VCEO +40V - 5 for 50p	} that postage
MPSH10 transistors (npn) fT – 650MHz, hFE 60, VCEO 25V - 10p each, 10 for 80p	} that postage
2N3904 transistors (npn) fT – 300MHz, hFE-150, VCEO +40V - 10 for 50p	} if ordered
2N3906 transistors (pnp) fT – 250MHz, hFE-150, VCEO -40V - 10 for 50p	} with books
BC517 Darlington (npn) fT – 200MHz, hFE-30,000, VCEO +40V - 13p each, 10 for £1.10	} or CDs
FETs - IRF510 – 50p; 2N3819 - 22p; 2N7000 - 10p; BS170 – 8p - all each	} add this
BF981 – dual gate MOSFET – 40p each	} postage
Pad cutter - 2mm shaft; 7mm o/s, 5mm i/s diam, gives a 5mm pad with 1mm gap £6.00	} as books
10K 10mm coils – 0.6uH, 1u2H, 1u7L, 2u6L, 5u3L, 11u0L, 45u0L, 90u0L, 125uL – all 80p each	} or DVDs
Magnet Wire – 18SWG – 2 metres – 60p; 20 & 22 SWG – 3 metres - 60p;	} do not
24, 25 & 27SWG – 4 metres - 40p; 30, 33 & 35SWG – 5 metres - 30p.	} travel well
Bifilar wire – 2 strands - red & green bonded together. Solderable enamel.	} with parts.
21SWG (0.8mm dia) – 2metres - £1; 26SWG (0.45mm dia) – 3metres – 70p	}
Litz wire – double silk covered multi-strand wire 7/0.4mm -12p, 14/0.4mm. 25p. Both for 3 metres.	}
All our wire is solderable enamel insulated. Max of 3 sizes per member per order	}
QRP heatsinks - TO92 – 30p; TO39/TO5 – 40p; TO18/TO72 – 60p (pics in Sprat 148)	}
Axial lead inductors (they look like fat ¼W resistors) these are low current	}
3.3, 4.7, 6.8, 10, 15, 18, 22, 33, 39, 47, 56, 100, 150, 220 and 1000 - all uH, all 18p each.	}
Toroid Cores – priced per pack of 5 – max of 2 packs of each per member	}
T25-2 – 50p, T25-6 – 60p, T30-2 – 70p; T30-6 – 80p; T37-2 – 80p; T37-6 – 80p; T50-1 - £1.00; T50-2 – 90p;	} Postage for
T50-6 – £1.10; T50-7 - £1.20; T50-10 - £1.20; T68-2 - £1.80; T68-6 - £2.40; T68-6 - £2.40; T130-6** - £2.40ea. FT37-43 – 90p	} toroids includes
FT50-43 - £1.20; FT37-61 - £1.20; FT50-61 - £2.40; Ferrite beads – FB43-101 (3.5mm dia x 3.2mm long,	} postage for all
1.2mm dia hole) – 40p for 5; BN43-2402 - £1.20; BN43-202 - £2.00; BN43-302 - £2.00; BN61-202 - £2.40.	} small parts
All toroids are plus postage – up to 5 packs = £1.20 (UK), £3.50 (EU), £4.50 (DX). Each additional 5 packs, please add 50%	}
** Except ** items – they are heavy and each counts as a pack (ask for quote if you want more than 2 of the large toroids)	}
SBSS PCB clamps * – single - £12, two - £20 all plus post (£3.50 UK & EU : DX – order direct from Rex please)	}
MeSquares & MePads * - £6.50 each plus post (UK & EU as parts for up to 4) : will DX please order direct from Rex)	}
STIX board * – 3" x 1", 80 x 0.15 square pads plus 2 x SOIC pads. £3.75 each. Will post with parts for no extra postage.	}
QRPme Brass sets * – PCB feet to lift the board off the table - £10 plus post as for SBSS clamps - DX order direct from Rex)	}
* these items from Rex's stock are pictured on the website.	}
Limerick Sudden kits RX & TX both single band (160 through 20m); ATU (80 through 10m) £40.00 each plus post UK - £3.50, EU - £5.40, DX - £8.00	}
Sprat-on-DVD – 1 to 160. Only £5 each to members plus postage, UK - £1.20, EU - £3.50, DX - £4.00	}
Sprat Binders – nylon string type – Black with club logo on spine -16 issues per binder – new stock - £6.00 each plus postage	}
(one: UK - £2.00, EU – £4.00, DX - £5.00. More - add £1.10, £1.50, £2.50 each)	}
Cheques (UK) and payable to G-QRP Club. MINIMUM ORDER for cheque or PayPal payments is £5	}
You can also pay by BACS. The members you will need to do that are - sort: 01-07-44 and a/c: 54738210	}
I can accept cash in GBPounds, or US\$/ euros (at the current exchange rates) – but please send securely! You can order via e-mail and pay by PayPal - use sales@grp.co.uk – and pay us in GBPounds and you MUST include your membership number and address please.	}
PayPal charge us about 4% so a contribution towards that is always welcome, or, send as a gift to friends/family - thanks	}